

RAYTOOLS

XCS3000S

Laser Cutting System Commissioning Manual



A CNC System

B Laser Delivery

C IOT

Document History

Edit date	Version	Topic, revision, action taken
2023/5/26	V1.2	First edition

Thank you for choosing our product!

This manual describes the installation and commissioning of laser cutting head in details so that you can use this product quickly. You can consult us directly for more details.

Due to the continuous updating of product functions, the product you receive may differ from the introduction in this manual in some aspects.

We reserve all rights in this document including the issued patents and other registered commercial ownership related to this document. It is strictly prohibited to use this document in an improper way especially to copy and disseminate it to third parties.

If you find any errors in this document, please inform us as soon as possible. The data contained in this manual is only used to describe the product and shall not be regarded as a statement of security interest.

For the benefit of our customers, we will constantly try to ensure that the products we develop comply with the latest technology.

Raytools AG

Email: sales@raytools.com

Website: www.raytools.ch

Disclaimer

- We reserve the right to change the design in order to improve the quality or expand the application or comply to manufacturing workmanship.
- We will not bear any responsibility for losses and accidents caused by wrong operation or improper handling of our products.
- Dismantling of product will lose all warranty claims excluding the normal replacement of worn parts and components required for maintenance or commissioning operations.
- Unauthorized modification of products or use of non-original spare parts will directly lead to the invalidation of warranty and liability exemption.
- It is recommended to only use the spare parts provided by us or submit them to us or the designated professional team for installation.

Use Regulations



- Ensure that the product is used in a dry environment.
- Ensure that the product is used in the environment required by EMC standards.
- The product is only allowed to run within the parameters specified in the technical data.

Personnel Responsibilities

- Be familiar with the basic provisions of work safety & accident prevention and have received equipment operation guidance.
- Read and understand basic safety instructions and operations.
- You must have studied the relevant regulations and safety instructions and understand the possible hazards.
- Comply with relevant regulations and implement corresponding protective measures.

Safety Instructions

Prevent Electric Shock

-  Parts of the laser head such as nozzle, sensor, sensor interface and attached fasteners may not be fully protected by the ground wire due to function fault. These parts may have low voltage. When installing electrical equipment, please pay attention to taking anti electric shock measures for relevant personnel.
-  Note that the equipment shall be grounded as specified.

Guard against Danger

- Never put your hands or other body under the laser head.
- Repair and maintenance work can only be carried out after the power is turned off.
- Do not exceed the specified maximum pressure.
- It must be ensured that the laser head is in normal condition at all times.
- All fasteners such as bolts and nuts must be tightened.



Laser Caution

- Avoid direct laser radiation or scattering to the skin.
- Do not stare at the laser beam even when wearing optical equipment.
- Use special laser protective eyeglasses that meet the requirements of safety standards IEC 60825-1.

Prevent Waterway Corrosion

- In order to avoid corrosion, use the specified coolant and comply with relevant requirements and specified maintenance intervals.

Noise Prevention

- The corresponding measures shall be specified or explained and observed in order to prevent personnel from being harmed by noise when the cutting air pressure is high.

Storage and Transportation

- Observe the storage temperature range allowed by the technical data.
- Take reasonable measures to prevent fire, vibration or impact.

Do not store in or near the magnetic field.

Catalog

1	Product Overview	7
1.2	System connection schematic	8
1.3	Technical parameters	10
2	Wiring instructions	11
2.1	EPC-1020 interface description	11
2.1.1	EPC-1020 interface description	12
2.2	EPC-2000 interface description	12
2.2.1	EPC2000 Interface Layout	14
2.3	EDS3000 Interface Description	15
2.3.1	EDS3000 Interface Description	16
2.3.2	Power supply interface description	17
2.3.3	Digital input interface	18
2.3.4	Digital output interface	19
2.3.5	Analog input interface	20
2.3.6	Analog input interface	20
2.3.7	PWM Interface	21
2.3.8	Sensor Interface	21
2.4	Servo Drive Interface	22
2.4.1	Yaskawa Servo Drive Wiring Diagram	24
2.4.2	HCFA Servo Drive Wiring Diagram	26
2.4.3	Panasonic Servo Drive Wiring Diagram	26
2.4.4	Delta Servo Drive Wiring Diagram	28
2.4.5	Fuji Servo Drive Wiring Diagram	30
2.6	EDS2010 Interface Layout	37
2.6.1	Power connector	38
2.6.2	Digital input interface	38
2.6.3	Output interface definition	38
3	Preparation for software installation	40
3.1	Self-hosted recommended configuration	40
3.2	Installation Software	40
3.2.1	Installation of cutting software	40
3.2.2	Filter by actual configuration	44
3.2.3	Software parameters setting	45
3.2.4	Save and activate the master	45
3.2.5	Registration is required to open the process, you can register through the mobile WeChat applets.	46
3.2.6	Use XC3000S software	46
4	Machine tool commissioning	48
5	Platform Configuration Tools	56
5.1	Interface Introduction	56
5.1.1	Menu bar area	57
5.1.2	PLC Variable Classification Area	70
5.1.3	Current configuration area	71
5.1.4	Online Module Area	71
5.1.5	PLC Variable Area	71
5.1.6	PLC Variable Pin Selection	71
5.1.7	Journal area	71
5.1.8	Status Area	71
5.2	Configure and change points	72
5.2.1	Operation on slave stations	72
5.2.2	Changing the slave connection order	76
5.2.3	Linking operations to slave sites	76
5.3	Example Demonstration	79
6	Precautions and exception handling	85
6.1	Electrical and commissioning considerations	85
6.1.1	Solenoid valve must be connected in parallel with a continuity diode	85
6.1.2	Power supply wiring specification	86
6.2	F-axis abnormality handling method	86

6.2.1	Control BM109 Cutting head abnormal treatment	87
6.2.2	BM111 Yaskawa Focusing Driver	87
6.3	Normal Questions	87
6.3.1	Host cannot enter the system	88
6.3.2	Enter the system sheet showing that the slave is not connected or not in OP status	88
7	Appendix	93
7.1	EDS2000 (Optional)	93
7.1.1	EDS2000 IO Card	93
7.1.2	EDS2000 Wiring Diagram	94
7.1.3	EDS2000 Laser Point Diagram	95
7.1.4	EDS2000 Servo Drive Interface	96
7.1.5	EDS2000 Servo Drive Interface	99
7.2	EDS3000 Wiring Diagram	109
7.3	EDS2010 Wiring Diagram	110
7.4	EPC-2000 Size Diagram	111
7.5	EPC-1020 Size Diagram	112
7.6	Parameter Definition	113
7.6.1	Parameter Definition	113
7.6.2	Pitch	116
7.6.3	X/Y-axis home position parameter	116
7.6.4	Z-axis home position parameter	117
7.6.5	Verticality correction	119
7.6.6	Laser head	119
7.6.7	Lasers	120
7.6.9	Dust removal valve	124
7.6.10	Customized Alarms	124
7.6.11	Custom buttons	126
7.6.12	Solid button	127
7.6.13	Switchboard	128
7.6.14	Lubrication	134
7.6.15	Segmented shaft servo parameters	134
7.6.16	Advanced options	137

1 Product Overview

The manual includes the summarized instruction of installation, setting, use and operation of professional RAYTOOLS XC3000S Series laser cutting software. Main functions are introduced here as there are too many modules to describe.

XC3000S Series laser cutting software is a professional CNC software of RAYTOOLS, adapted to industrial laser production application. This software can work with popular laser cutting equipment in the market with its advantages covering rich functional modules, independent process database, along with human machine interface, which is smooth and convenient to operate for users.

EPC-2000	EDS-3000	TTA
		
<p>网线 EtherNET cable</p>	<p>传感器线缆 Sensor cable</p>	
		
<p>EPC-1020 (选配) EPC-1020(Optional)</p>	<p>手柄套件 (选配) Pedant(Optional)</p>	<p>二极管 (选配) Rectifier diode(Optional)</p>
		
<p>控制线 (选配) Control cable (Optional)</p>	<p>TTW (选配) TTW (Optional)</p>	<p>EDS-2010 (选配) EDS-2010 (Optional)</p>
		

1.2 System connection schematic

Bus type servo connection method

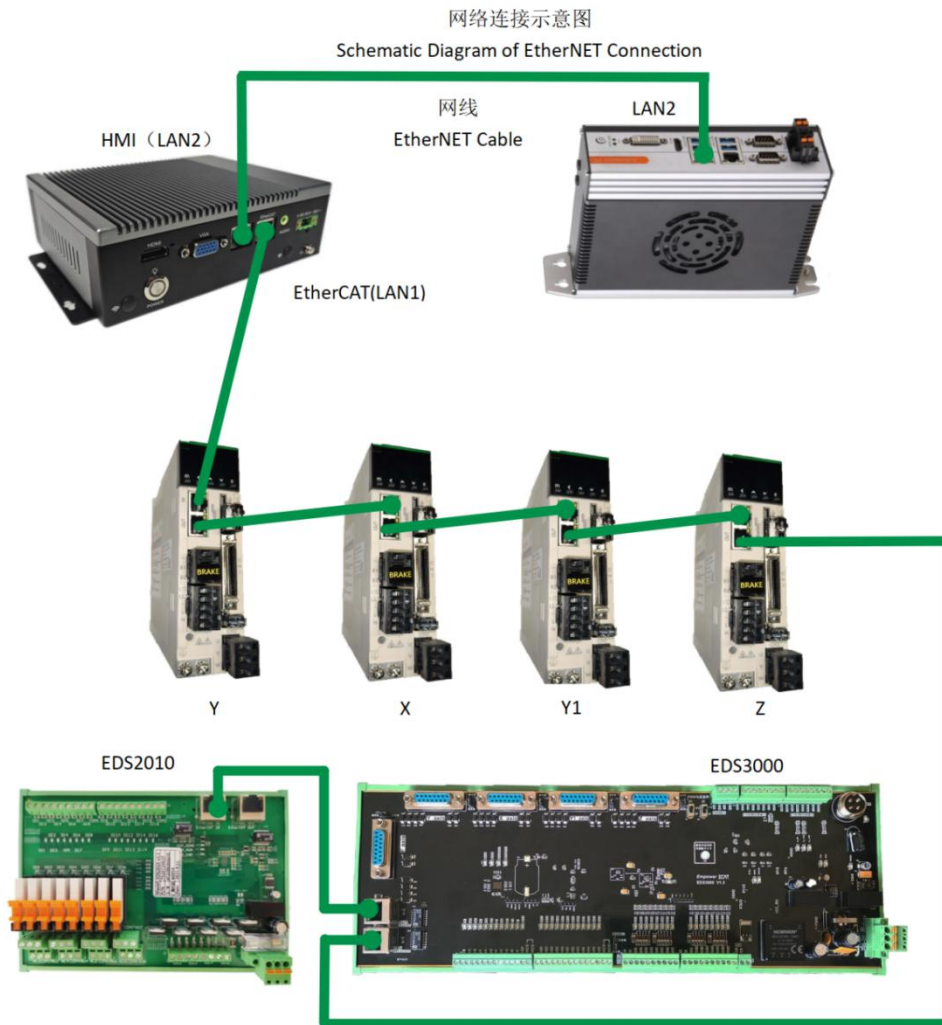

自动调焦及调高器接线示意图
Schematic Diagram of Auto-Focus and Height Tracking

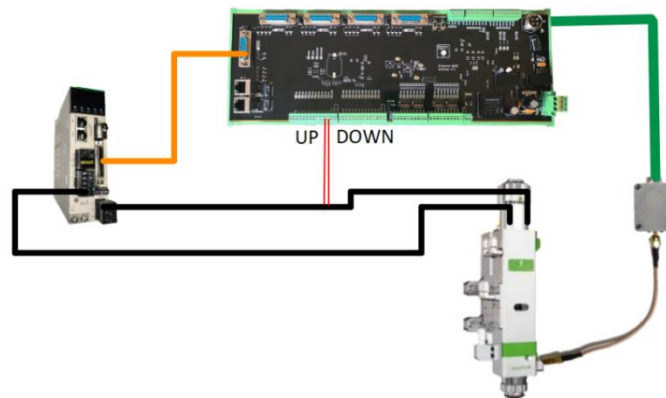

XC3000S Series Laser Cutting System Commissioning Manual

Pulse type servo connection method

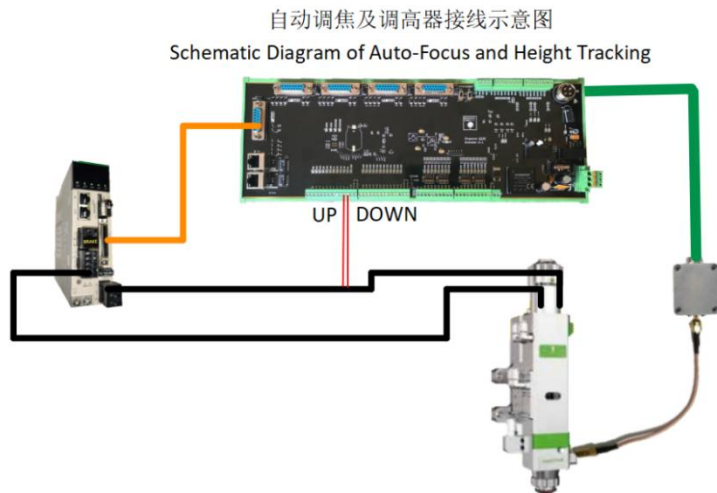
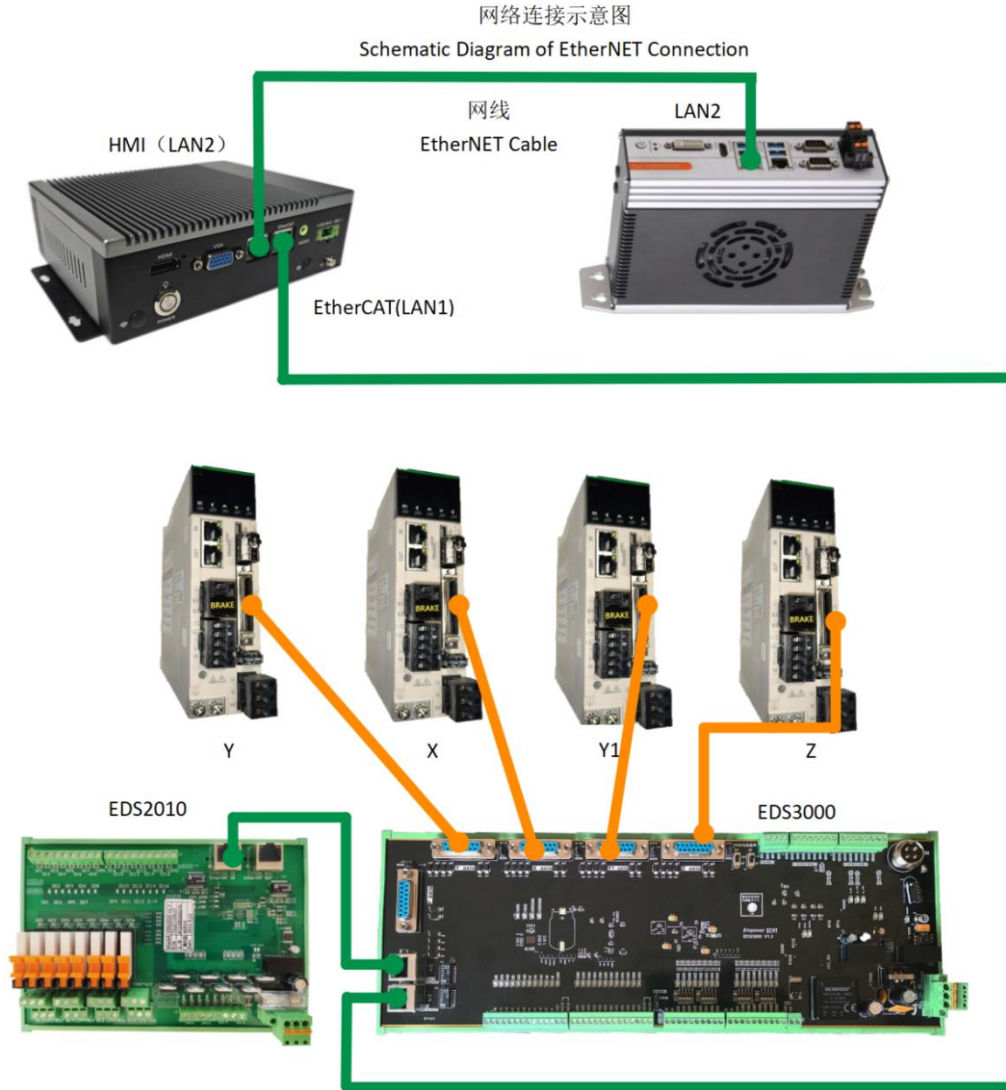

1.3 Technical parameters

Motion Control	Control Method	EtherCAT	Support standard EtherCAT for flexible access to the system topology
		Pulse	5-way universal interface of axis, which can be adapted to different types of servo drives and provide high-precision position feedback, supporting CiA402 standard
			1-way F-axis interface dedicated to laser head focus control
	Motion Performance	Control Period	1ms
Acceleration and deceleration		S-type	
Advanced-planned speed with motor reversing and intelligent lifting speed			
IO Function	24 ways of digital inputs with flexible configuration of high/low side input		
	16 ways of 24V generic digital outputs		
	4 ways of 16-bit high-resolution AD inputs with a voltage range -10V ~ +10V		
	2 groups PWM outputs, supporting 24V and 5V PWM signals (adjusting by picks), Frequency range 0~30kHz with an accuracy of 1%		
	1 laser follow control interface, with external capacitance amplifier, to achieve EtherCAT-type high-precision capacitive height control		
Work Environment	Temperature	0° C ~ +80° C	
	Environmental pressure	0.096MPa ~ 0.106MPa	
	Relative humidity (non-condensing)	0 ~ 70%	
Power Requirement	EPC-2000	24V DC (9-36V wide voltage module)	
	EDS-3000	24V DC	

2 Wiring instructions

2.1 EPC-1020 interface description

EPC-1020 (optional) is our new HMI PC, with good performance in graphics processing and response speed.

EPC-1020	
Network Card	2× Gigabit NIC
USB	4 x USB3.0, 1 built-in USB2.0 onboard
Storage Device	1 x mSATA HDD card slot 1 x M.2(B Key, Type 2280)SSD Card slot, SATA signal
Ambient temperature	-20°C~60°C
Ambient humidity	5%~95% (non-condensing)
Display	Support both HDMI / DVI-D interface
Power supply	DC12~24V ±10%, Over-current, over-voltage and anti-reverse protection
Size	(L x W x H) 200mm x 154.5mm x 57.6mm

2.1.1 EPC-1020 interface description

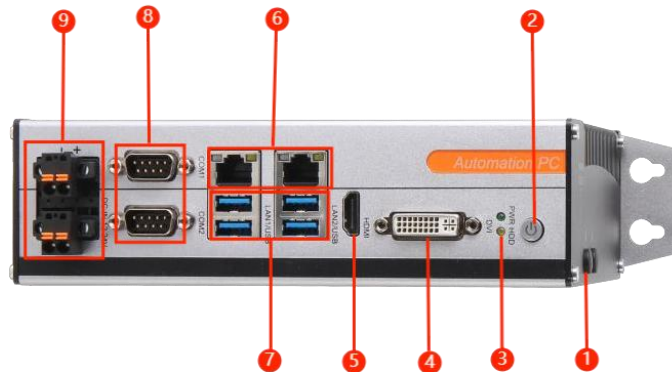

1	Antenna interface
2	Startup button
3	Status light
4	DVI-D
5	HDMI
6	2×Gigabit NIC
7	4×USB
8	2xRS232/RS485
9	DC IN 12V~24V

➤LAN2 connects with master control EPC-2000 for human machine interaction.

➤24V (12V~24V) DC power supply input.

2.2 EPC-2000 interface description

EPC-2000 real-time EtherCAT master PC is the core component of motion control system of the machine, developed by Raytools technology with motion control algorithm and professional control logic designed for laser use. It also supports a variety of modes like online upgrade or real-time upgrade, with features

System Commissioning Manual

including good stability, anti-interference ability, high-performance computing mode, and easy to upgrade and operate.

EPC-2000	
Network Card	2×Gigabit NIC
USB	4×USB2.0, 2↑USB3.0
Storage Device	1×2.5HD,1×MSATA
Ambient temperature	-20°C~60°C
Ambient humidity	5%~95%
Display	Support both HDMI / VGA interface
Power supply	9-36V wide voltage module
Size	(L x W x H) 181.7mm×126.5mm×54mm

2.2.1 EPC2000 Interface Layout



1	Startup button
2	HMI (LAN2) master control module communication interface
3	EtherCAT (LAN1) connection interface
4	DC power input 9-36VDC

➤ EtherCAT (LAN1) port is defined as EtherCAT connection interface to be connected with the servo motor and EDS board.

➤ HMI (LAN2) port is defined as the connection to the IPC / EPC-1010.

➤ Please input 24V (9-36V wide voltage) DC power.

2.3 EDS3000 Interface Description

EDS3000 is an EtherCAT-based slave interface board with a rich set of IO, motion control and laser follow interfaces and resources, especially for signal acquisition and motion control applications in the laser industry.

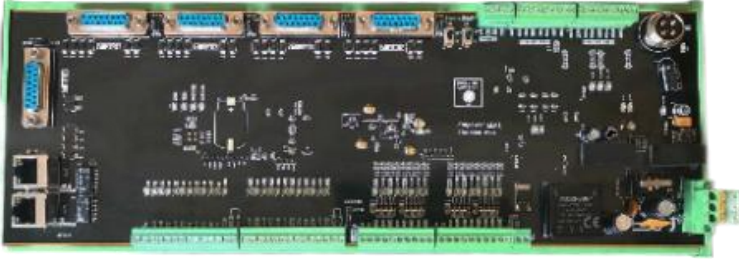
EDS3000			
Module	Qua.	Description	Remark
Power supply	/	24V DC	Voltage range (18~36V)
PWM	2	5V、24V; Duty cycle: 0%-100%; Fre.: 20kHz	
DA	4	Output: 0~+10V; 16bit; Accuracy: 10mV	
AD	4	Input: 0~+10V; 16bit; Accuracy: 10mV	
Digital input	24	24V/0V (variable) , COM port wiring control	
Digital output	16	Single output high level 24V DC	
Ambient environment		Temperature : 0~+55 °C ; Ambient humidity (non-condensing) : 5%~95%	
Size		129.36*350.5	

2.3.1 EDS3000 Interface Description

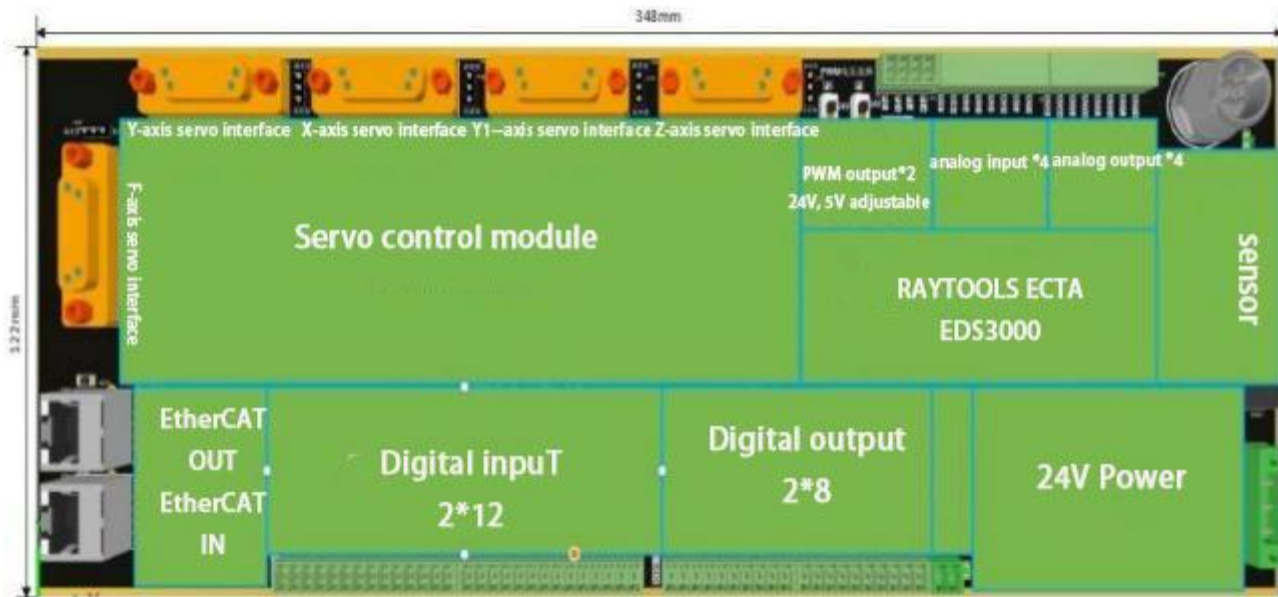

The board has a boundary dimension of 122mm*348mm and can be assembled on a module rack for mounting on the DIN C45 rail.

On the upper left there are 4 DB15 ports for external servo drives. From left to right, they are Y-axis, X-axis, Y1-axis and Z-axis. At the lower left, there is one F-axis interface and two RJ45 ports for external F-axis servo drive and EtherCAT cables.

The upper right ports are 2 PWM output ports, 4 analog input ports, 4 analog output ports and 1 laser head height sensor port respectively. The lower right port is a 24V power input port with 2 PWMs which can work with 24V or 5V output.

From left to right on the lower part, there are 12 dedicated digital inputs, 12 generic digital inputs, 16 generic digital outputs, and 1 brake output connector.

2.3.2 Power supply interface description

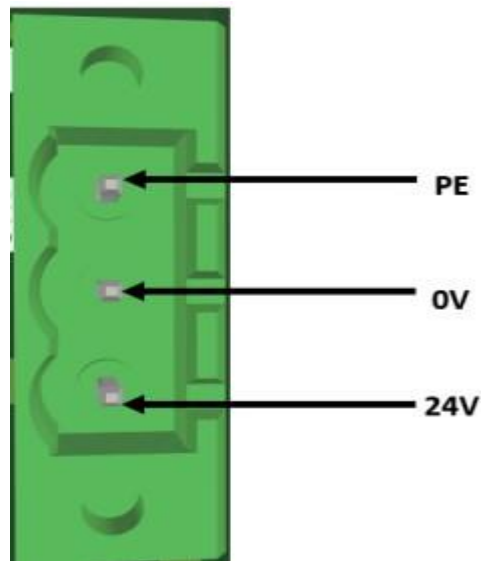

EDS3000 board power interface needs to be externally connected to the DC24V switching power supply, where the 24V, 0V and PE input terminals are connected to the output interface 24V, 0V and PE of external switching power supply respectively.

2.3.3 Digital input interface

When COM1 is connected to 24V, the input signal is active low; when COM1 is connected to 0V, the input signal is active high. Take NPN and PNP sensors as an example:

When using the NPN type limit, the COM1 port is connected to 24V.

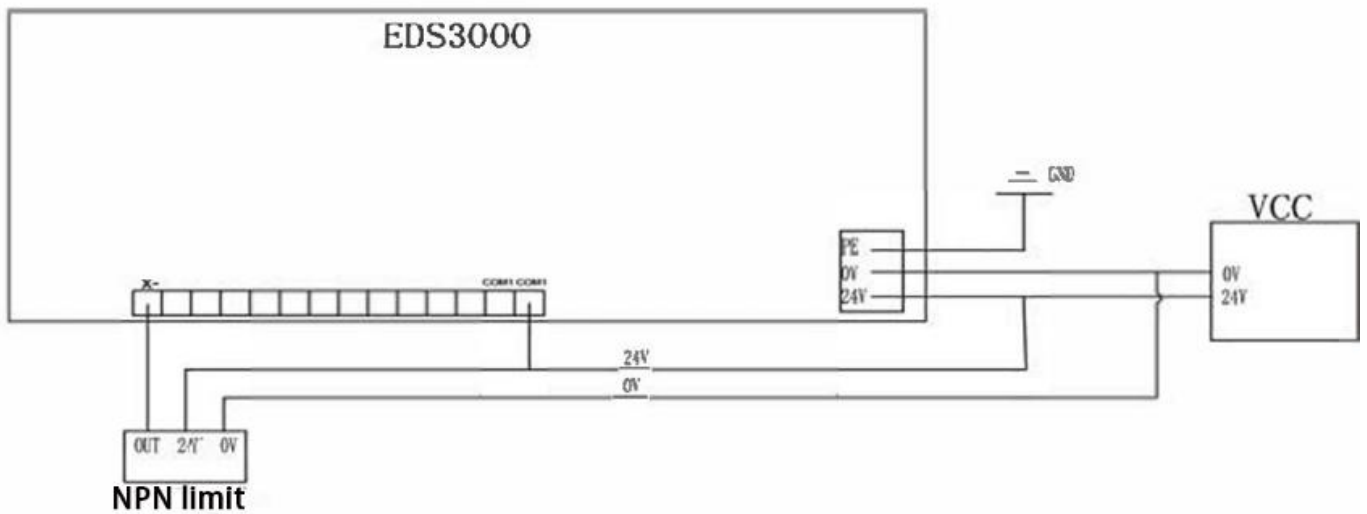

When using PNP type limits, the COM1 port is connected to 0V.

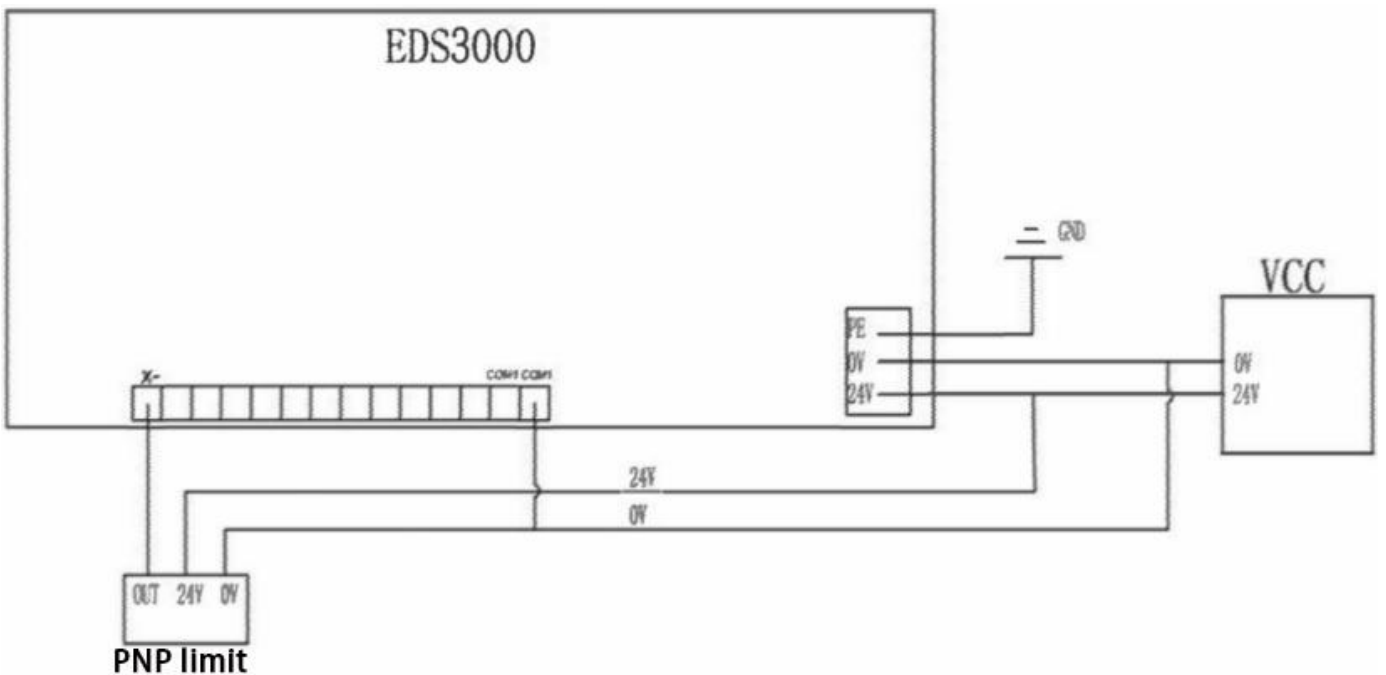

When COM1 is connected to 24V, the input signal is active low; when COM1 is connected to 0V, the input signal is active high. Take contact switch as an example.

Active low-level connection

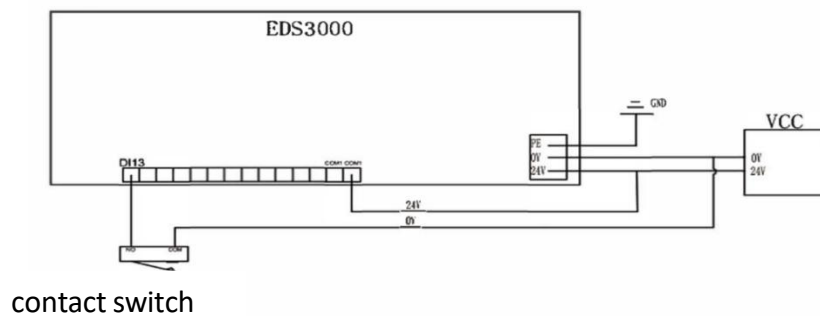

Active high-level connection

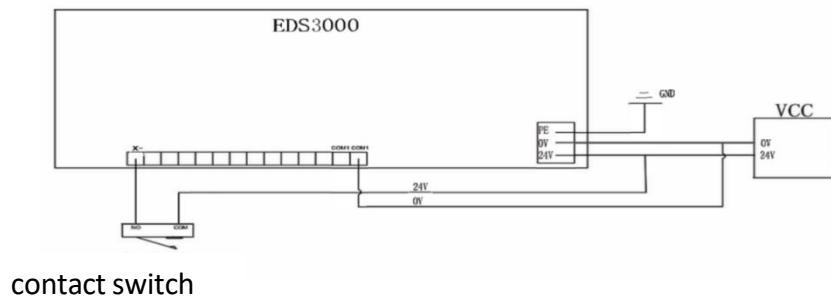

2.3.4 Digital output interface

DO1-DO16 are 16-way digital output interfaces (24V output), which can be configured as "oxygen valve", "laser enable", "focus enable", "indicator" and other related control interfaces. The definition of each port is preset in the software, as shown below:

System Commissioning Manual

All DO1~DO16 output 24V high level, with the maximum output current of 0.5A. If it's connected to a high- power load, please connect an external relay and connect a current- continuing diode (MIC 10A6) in parallel with the oxygen and nitrogen solenoid valve.

In addition, it is better to use another power supply DC24V2 control valve, which can be separated from the system IO power supply DC24V1.

Take the shown below as an example:

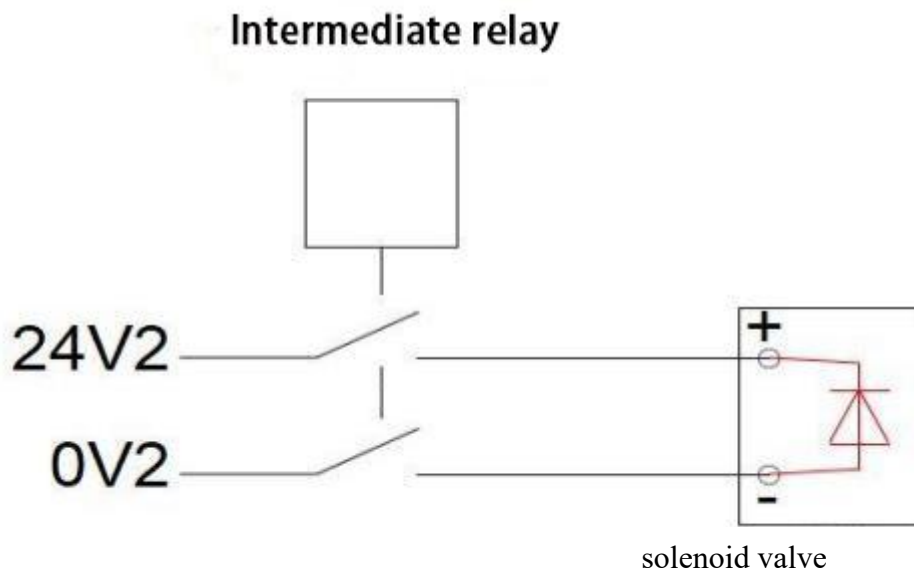

2.3.5 Analog input interface

A total of 4 A/I analog input interfaces are provided, with a signal input range 0V ~ 10V.

2.3.6 Analog output interface

A total of 4 A/O analog output interfaces are provided, with a signal output range 0V ~ 10V. The way is as shown in the figure.

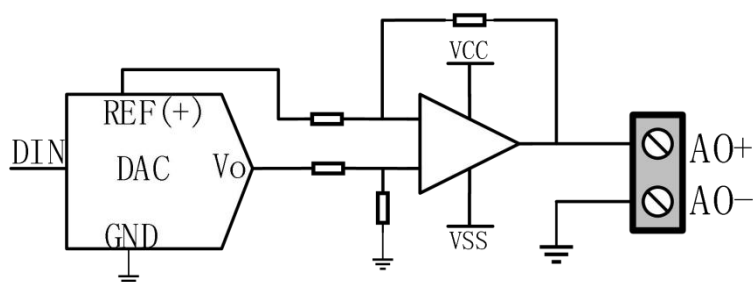

2.3.7 PWM Interface

There are 2 PWM pulse width modulation signals, which can be used to control the average power of the fiber laser. The PWM signal supports 24V or 5V (manually adjusting), and the duty cycle is adjustable from 0% to 100%.

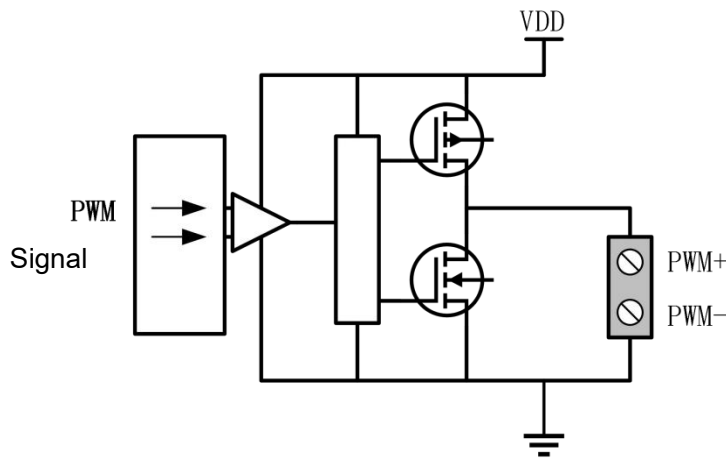

2.3.8 Sensor Interface

There is a sensor interface circuit for laser head height adjustment. The output signal from the receiving capacitor amplifier circuit is fed to the CPU through the conditioning circuit, and the interface is defined as follows:

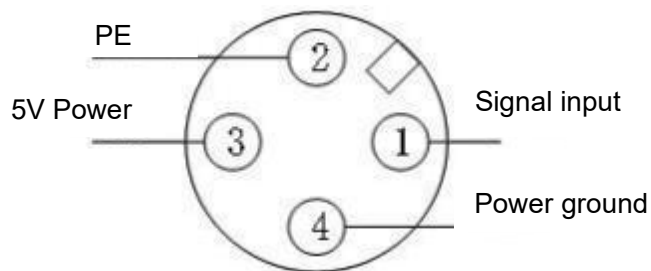

2.4 Servo Drive Interface

1. 5 servo control interfaces on the board card to connect the generic axis (X, Y, Y1, Z and F axes) interface use a double-row DB15 female socket, as shown in the following figure:

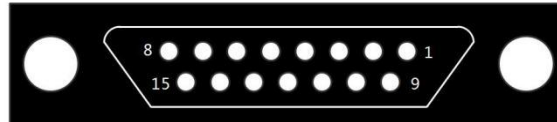

The pins are defined as follows:

Servo interface signal description					
Foot No.	Signal Name	Function	Foot No.	Signal Name	Function
3	A+	A-phase encoder pulse input +	2	XD+	Axis rotation direction switching output +
11	A-	A-phase encoder pulse input -	10	XD-	Axis rotation direction switching output -
4	B+	B-phase encoder pulse input +	14	ALM	Servo alarm input
12	B-	B-phase encoder pulse input -	6	SON	Servo enable output
5	Z+	Z-phase encoder pulse input +	7	CLR	Axis Clear Output
13	Z-	Z-phase encoder pulse input -	8	P24V	24 V power supply
1	XP+	Axis speed control output +	15	PGND	Power Ground
9	XP-	Axis speed control output -			

System Commissioning Manual

Note: EDS3000 board ALM signals are active low, which can be switched to active high by the jumper cap next to the corresponding axis port. The alarm polarity of the axis port can also be set in the configuration



tool to change the alarm trigger conditions.

2. Servo drive control signal wiring diagram

Note: The following should be noted when connecting the servo drive:

EDS3000 uses a pulse + direction signal to control the servo drive, and it must be confirmed that the drive supports this mode; and whether the type of servo drive enable signal (SON) selected is active low;

Confirm the servo drive parameters are set correctly. If the servo cannot run, the parameters should be set to not use the "forward and reverse input prohibition";

2.4.1 Yaskawa Servo Drive Wiring Diagram

Servo control interface

EDS3000-DB15 2-pin (male)

shielded wire

Yaskawa servo 50 Pin interface

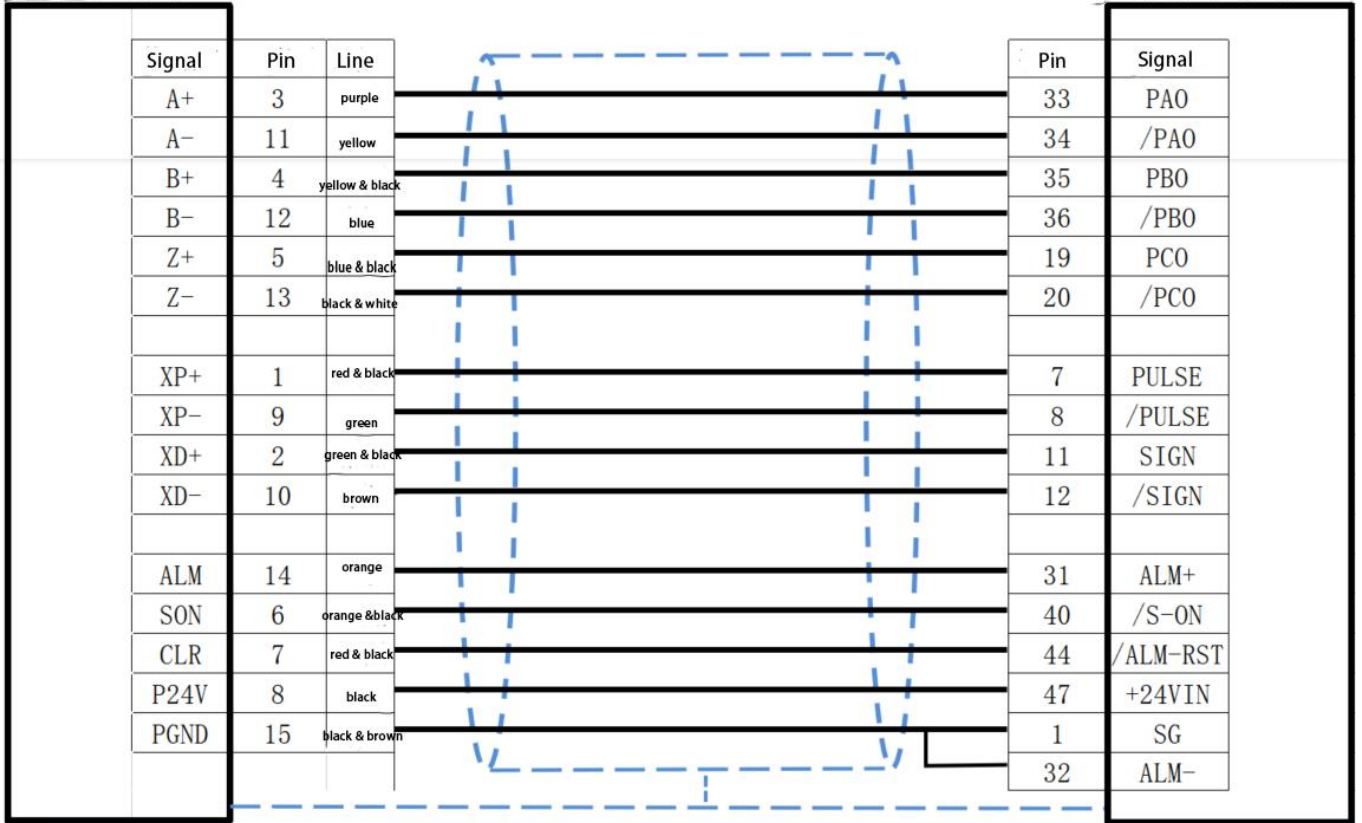

Yaskawa Servo Parameter Setting		
Parameter Type	Recommended Value	Setting range
Pn000	0.0.1.0	0.0.x.0 (0 speed; 1 position) 0.0.0.X (0 forward; 1 reverse)
Pn000	0.1.0.1	0.X.0.0 (0 3-phase power; 1 single-phase power); 0.0.0.X (0 display setting, 1 display all parameters)
Pn200	0.0.0.0	0.0.0.X (0pulses +direction positive logic, 5 pulses +direction negative logic) . X.0.0.0 (linear 1M)
Pn50A	8100	Positive turn prohibition cancellation
Pn50B	6548	Reverse prohibition cancellation

2.4.2 HCFA Servo Drive Wiring Diagram

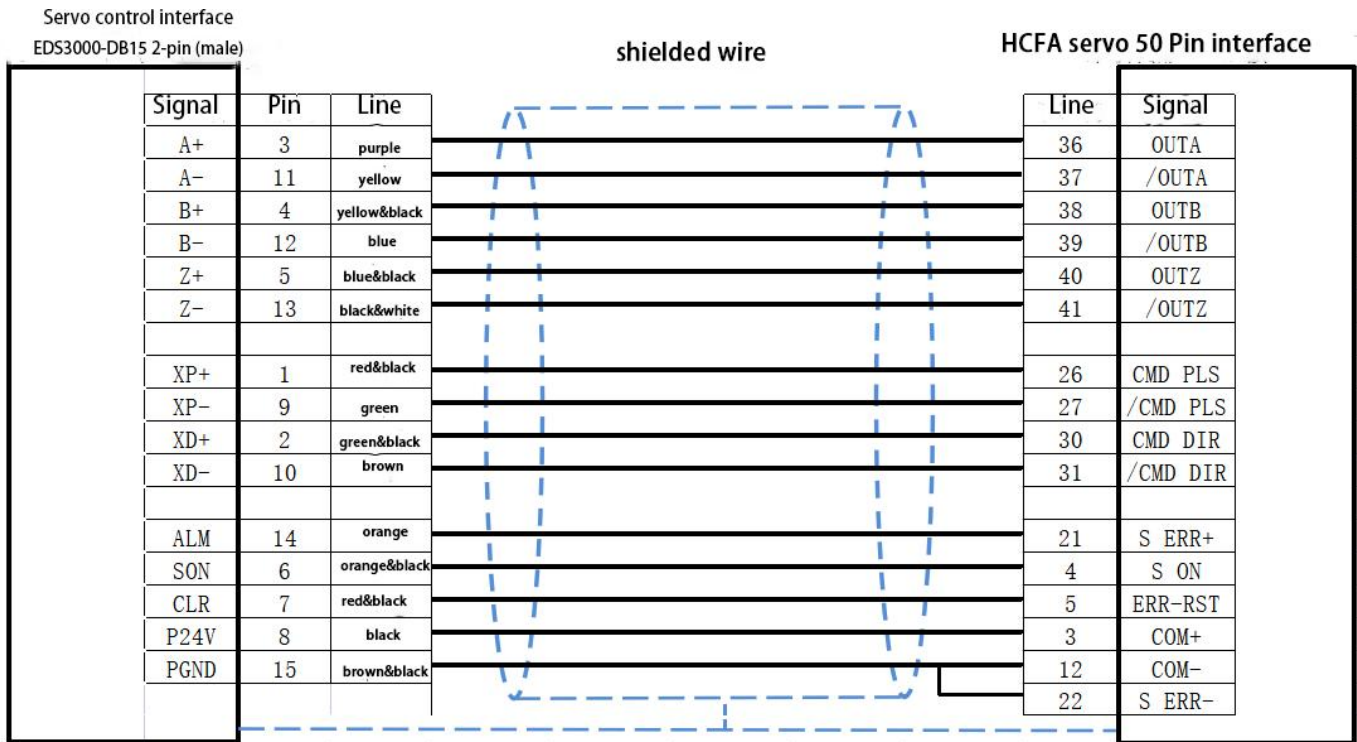

HCFA Servo Parameter Setting		
Parameter Type	Recommended Value	Setting Range
P00-01	0	0 Position mode; 1 Speed mode; 7 EtherCAT mode
P00-07	0	0: Pulse + direction positive logic; 1 Pulse - direction negative logic
P00-16	1	0: forward; 1: reverse

2.4.3 Panasonic Servo Drive Wiring Diagram

Servo control interface
EDS3000-DB15 2-pin (male)

Panasonic servo 50 Pin interface

shielded wire

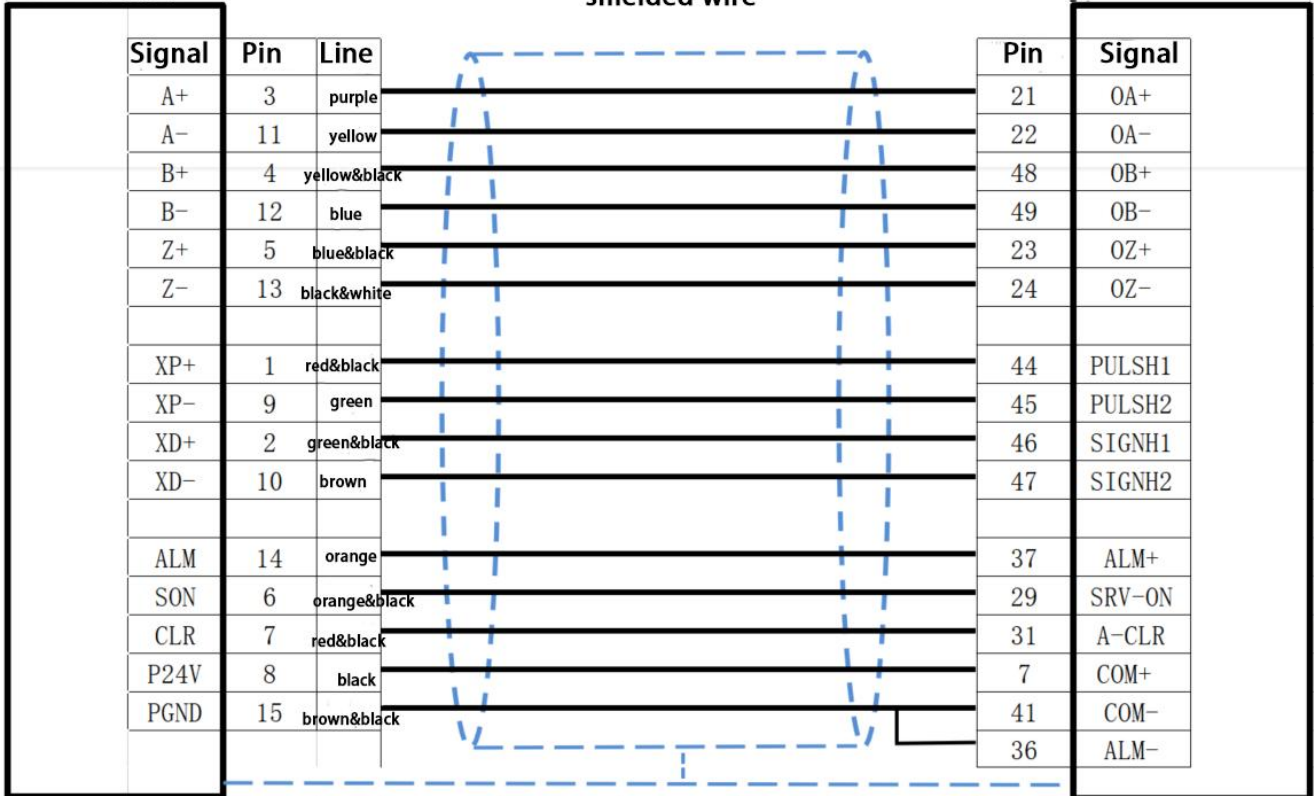

Panasonic Servo Setting Parameters

Parameter Type	Recommended Value	Setting Range
Pr001	0	0: Position control, 1: Speed control
Pr007	3	3: Pulse plus direction
Pr005	1	1: High-speed pulse 3mpa; 0: Low- speed pulse 500kpps

2.4.4 Delta Servo Drive Wiring Diagram

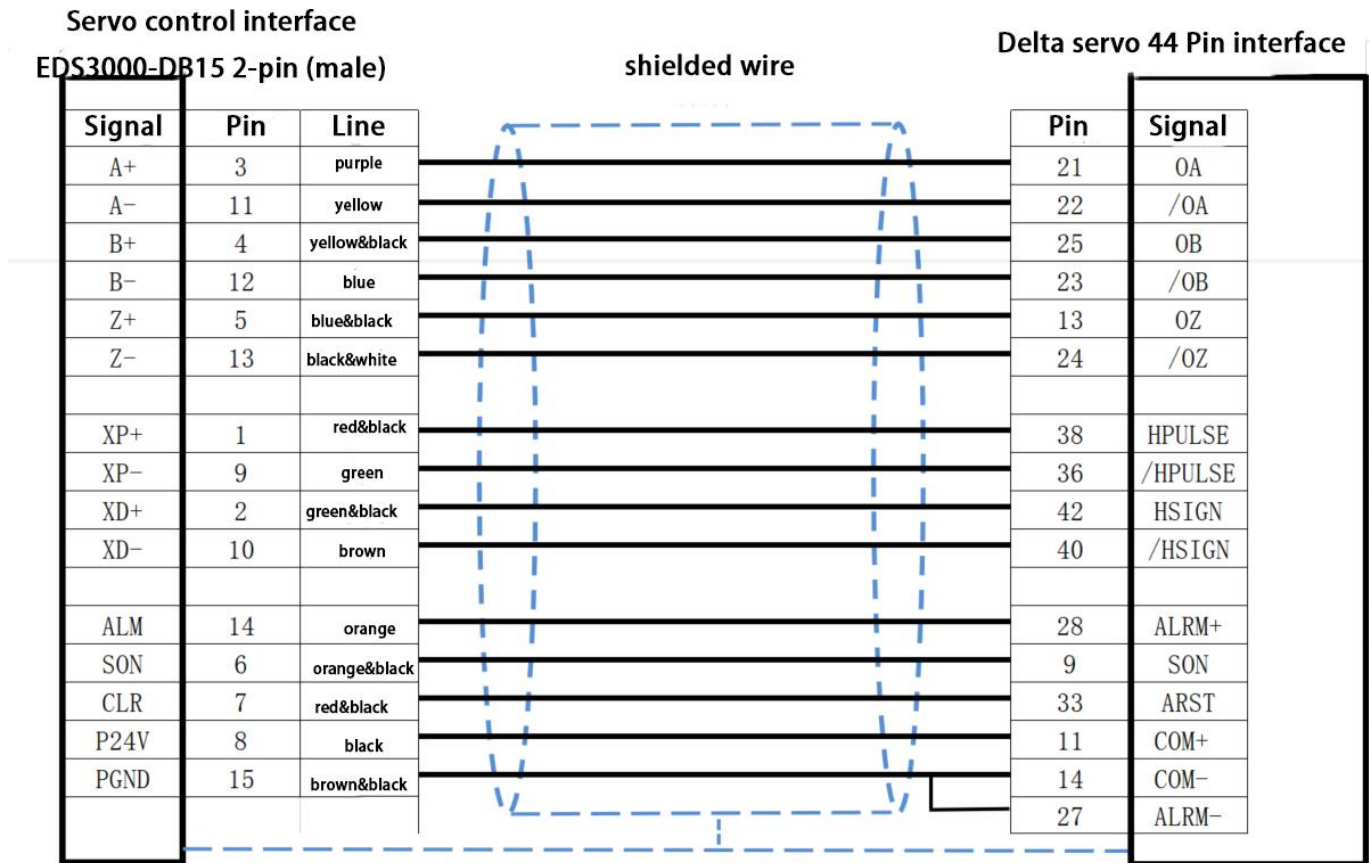

Delta B Series Servo Drive Wiring Diagram

Servo control interface

EDS3000-DB15 2-pin (male)

shielded wire

Delta servo 50 Pin interface

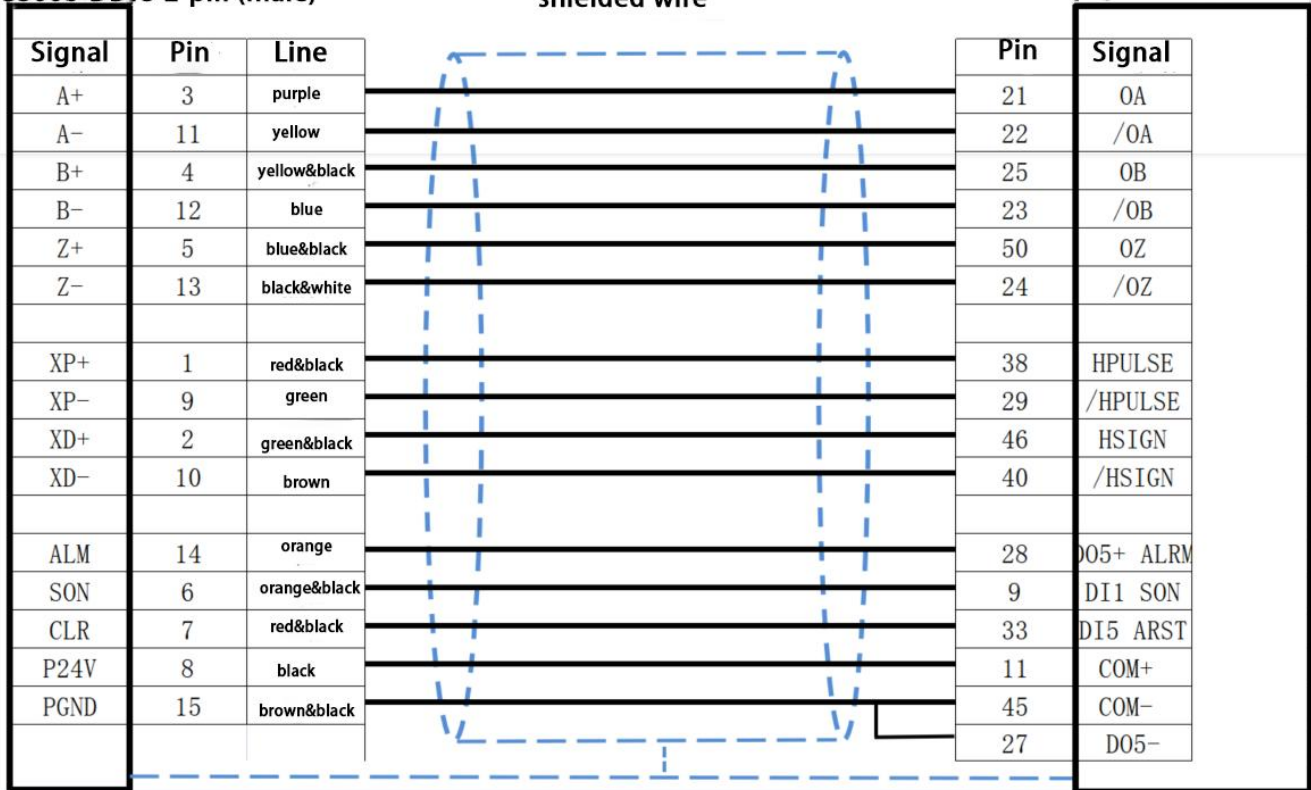

Delta A2 Series Servo Drive Wiring Diagram

Delta Servo Setting Parameters		
Parameter Type	Recommended Value	Setting Range
P1-00	0x1002	Thousands of bits 1 High-speed differential
P1-01	0x0000	Percentile 1 is the reverse
P2-10	0x0101	DI1

2.4.5 Fuji Servo Drive Wiring Diagram

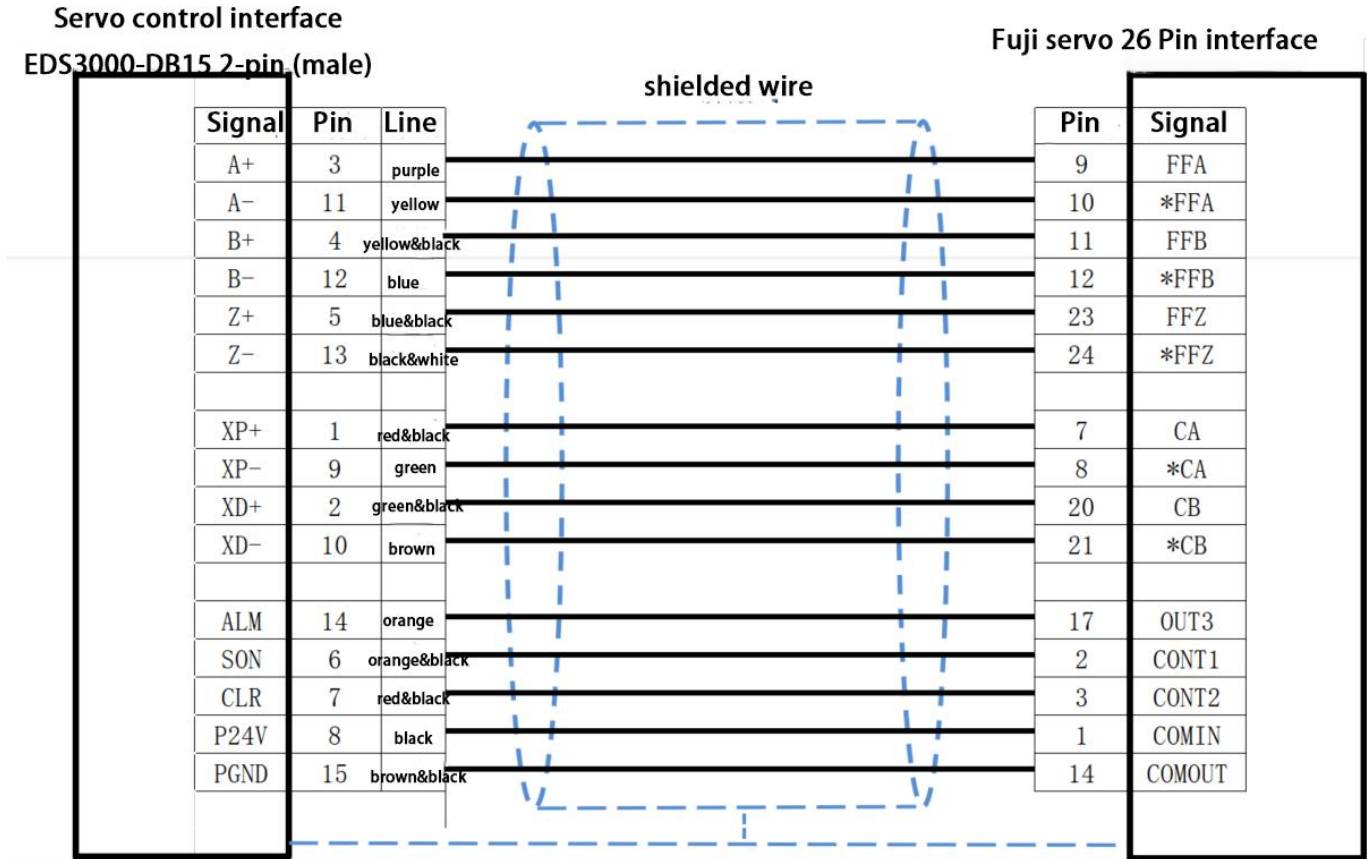

Fuji servo 26 Pin interface

Fuji Servo Setting Parameters		
Parameter Type	Recommended Value	Setting Range
PA-101	0	0...position 1...speed 2...torque 3...position <=> speed 4...position <=>Torque 5...Speed <=> Torque 6...Extended mode 7...Positioning operation
PA-103	1	0...Differential input: Command pulse/symbol 1...Differential input: Forward pulse/reverse pulse 2...Differential input : 90° bit phase difference 2 signal 10...Open collector input : Command pulse/symbol 11...Collector Open-collector input: Forward pulse/ reverse pulse 12...open collector input :90° bit phase difference 2 signal

2.4.6 LEAD-Motion Servo Drive Wiring Diagram

Servo control interface

EDS3000-DB15 2-pin (male)

LEAD servo P series interface

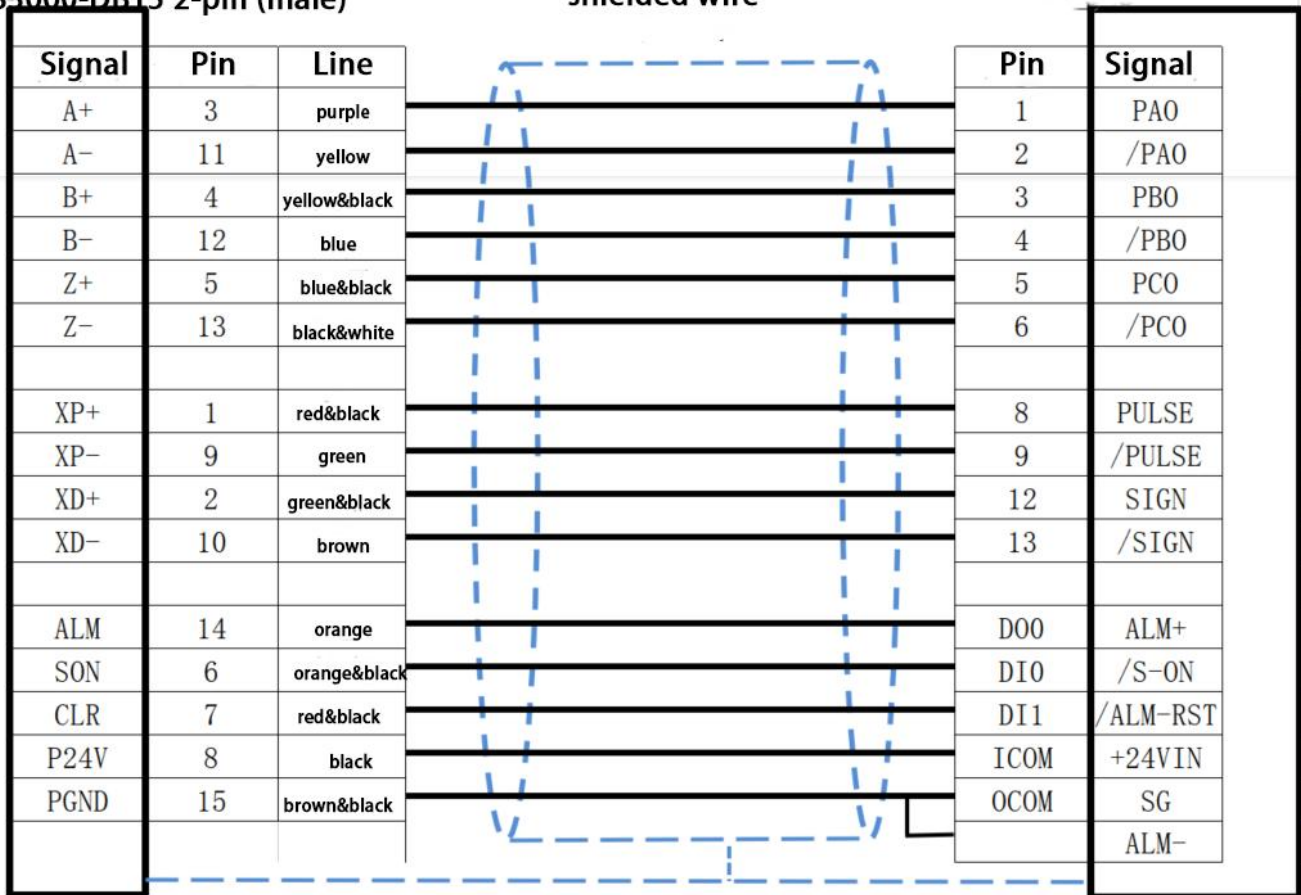

P Series Servo Drive Wiring Diagram

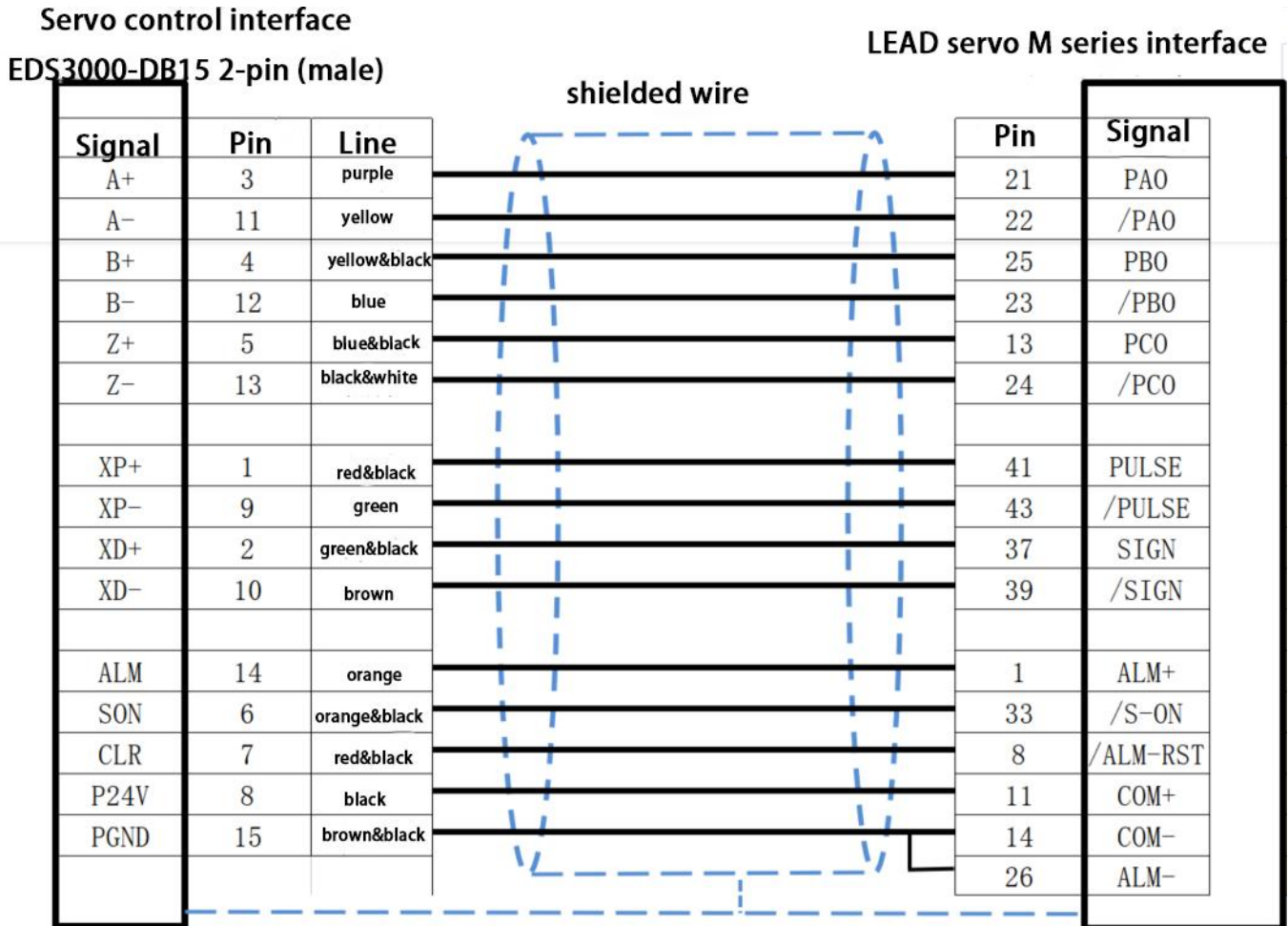

M Series Servo Drive Wiring Diagram

2.5 Laser Wiring

2.5.1 Max Chuangxin Fiber Laser Wiring Diagram

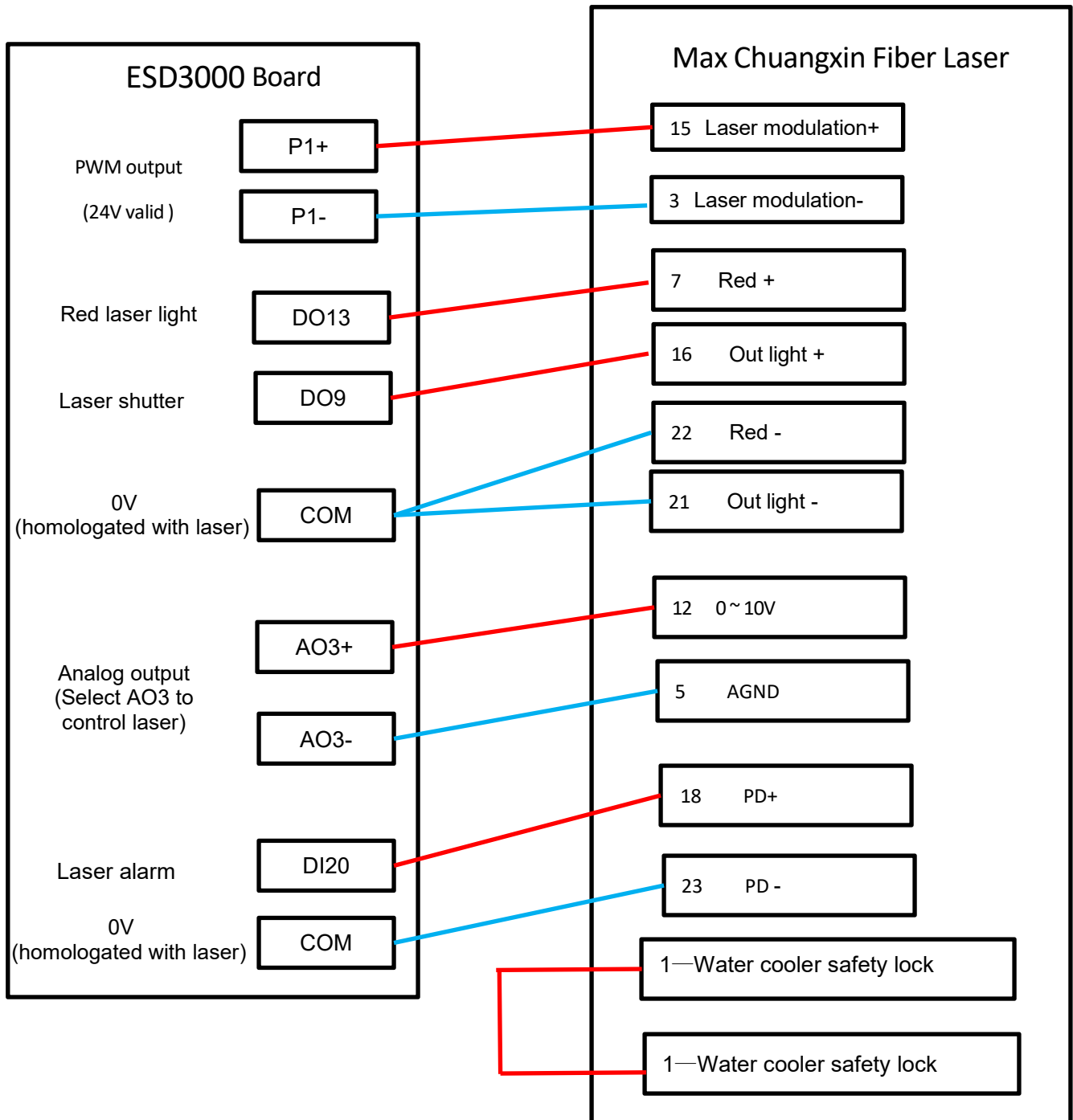

Notes:

1. PD+ PD- is the laser alarm output, connected to the DI20 input of the EDS3000 terminal block, "Platform Configuration - Digital Input - DI20" default Laser alarm (NO);
2. The red light and the light enable ground pin can be integrated into any 0V of the EDS3000 terminal block together to ensure the same source as the laser
3. Chuangxin laser PWM selects 24V to control.

2.5.2 Hotspot Single-mode Continuous Fiber Laser Wiring Diagram

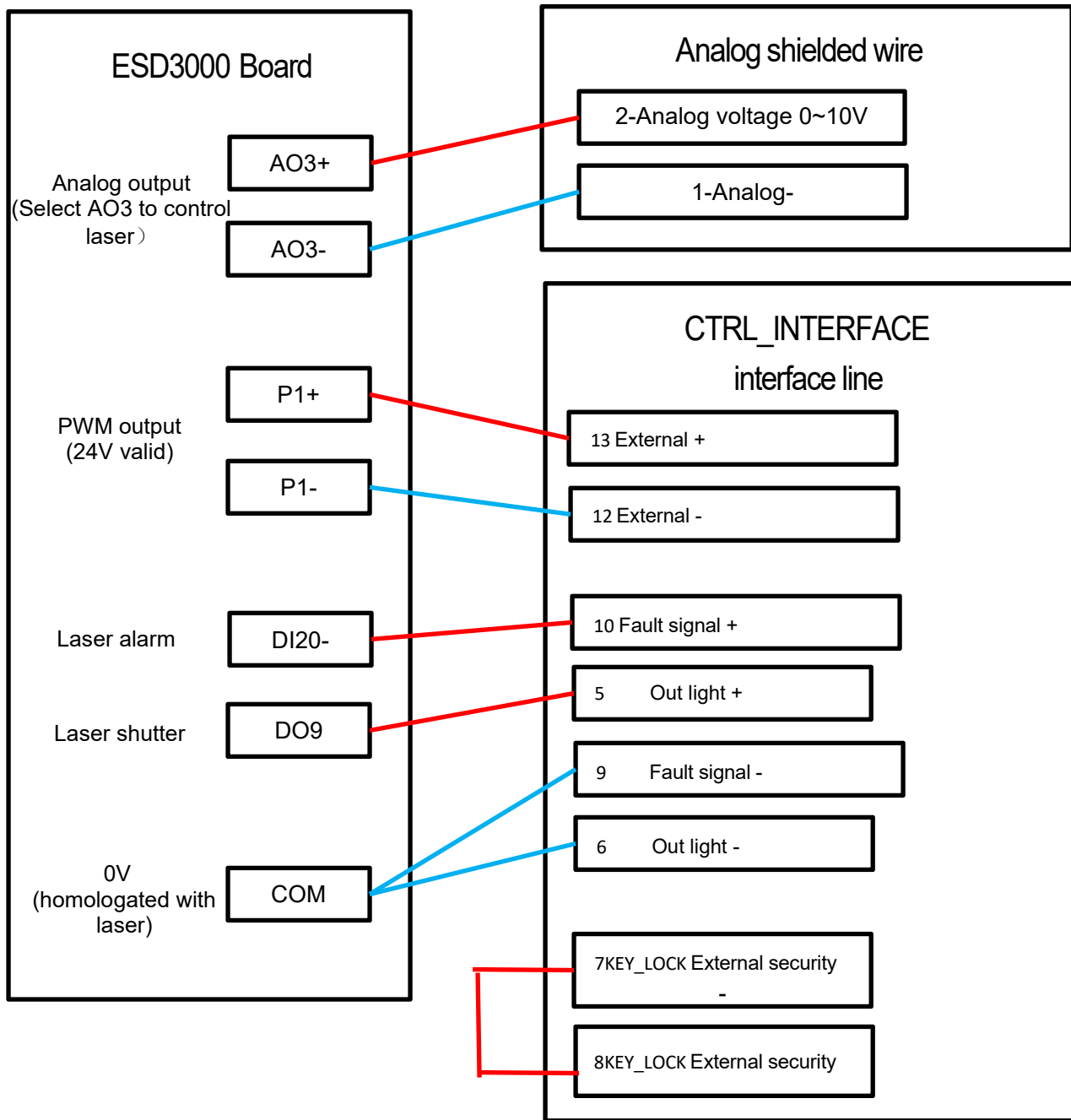

Notes:

1. PD+ PD- is the laser alarm output, connected to the DI20 input of the EDS3000 terminal block, "Platform Configuration - Digital Input - DI20" default Laser alarm (NO);
2. The red light and the light enable ground pin can be integrated into any 0V of the EDS3000 terminal block together to ensure the same source as the laser
3. Hotspot laser PWM selects 24V to control.

2.5.3 Raycus RFL-C3000 Continuous Fiber Laser Wiring Diagram

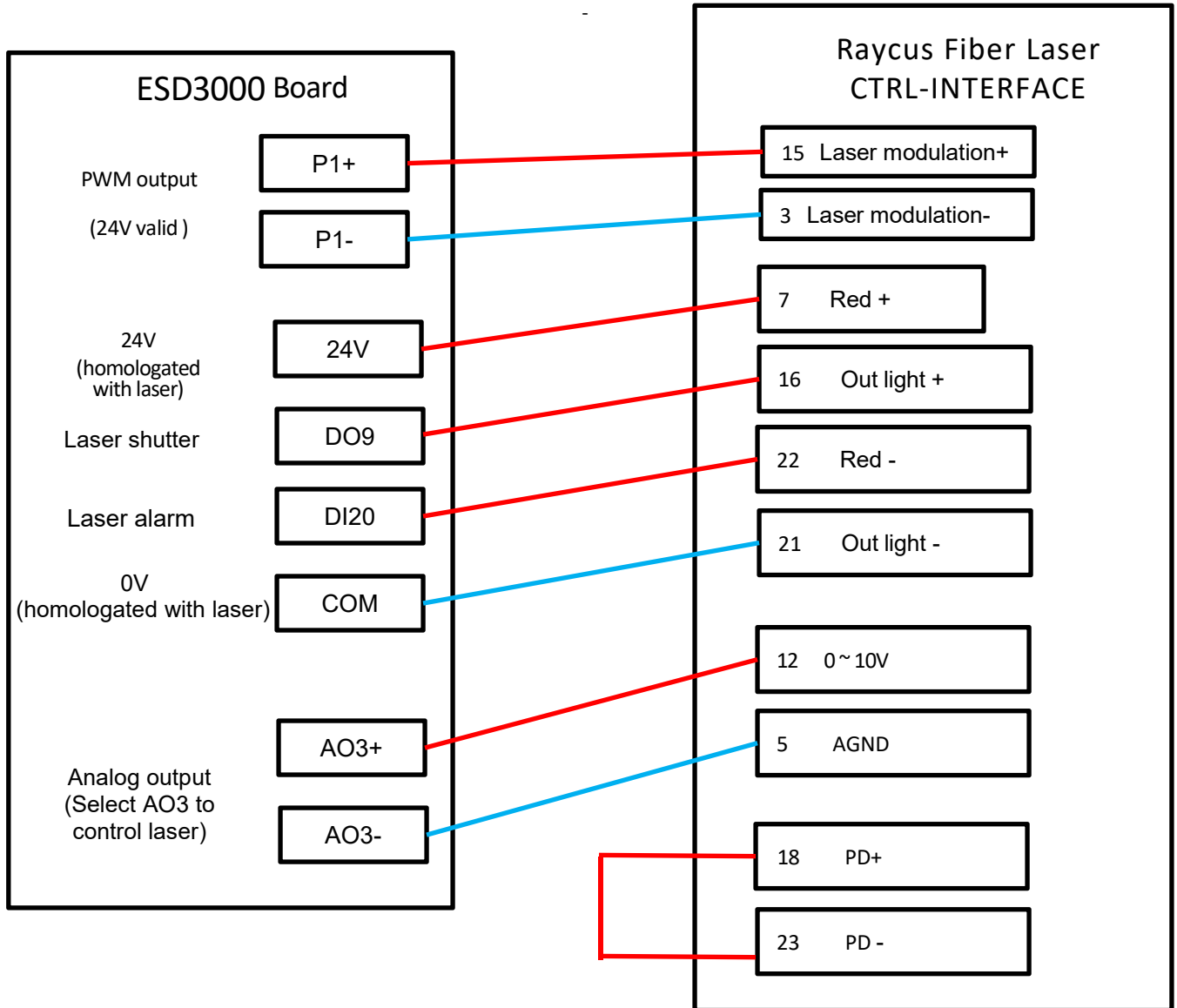

Notes:

1. In REM state, the control board is powered up to give a high level to enter the external AD mode.
2. REM laser enable and red light for the same interface, up enable for closing red light, down enable for opening red light.
3. REM laser PWM selects 24V to control.
4. Laser system fault alarm output high level to the card.

2.6 EDS2010 Interface Layout

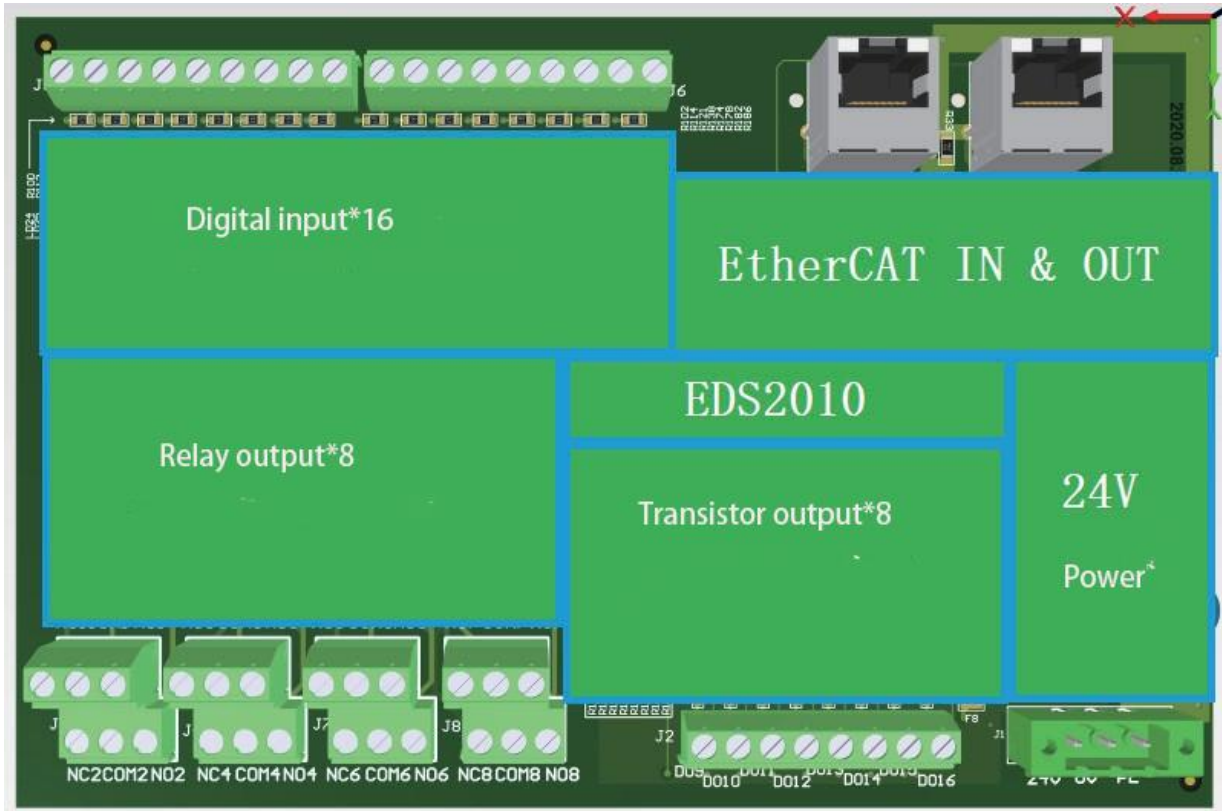

The card has a form factor of 185mm*122mm and can be assembled on a module frame for use on DIN C4535 rails. The functional layout is shown in the figure below.

The upper left two RJ45 ports are connected to the EtherCAT cable, EtherCAT IN and EtherCAT OUT.

The upper right is the 16 digital input interfaces. For left: channel 1 to channel 8 and its common terminal; for right: channel 9 to Channel 16 and its common side.

The lower left to right is 8 sets of relay outputs and 8 transistor outputs.

The lower right corner is the board power supply, 24V power connector

2.6.1 Power connector

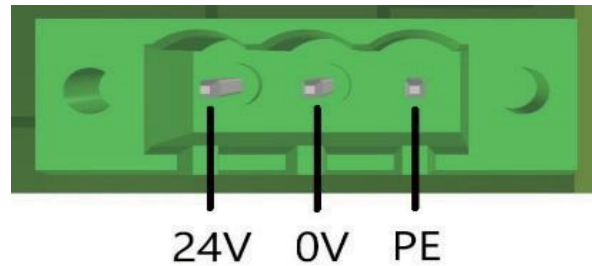

The EDS2010 board power interface needs to be connected to an external DC24V switching power supply, where the input terminals 24V, 0V and PE are connected to external switching power supply 24V, 0V and P E respectively.

2.6.2 Digital input interface

There are 16-way digital input DI interfaces, which are divided into two groups, each 8-way for a group and high and low active can be configured in groups. The common terminal of DI1-DI8 is COM1, and the common terminal of DI9-DI16 is COM2, where the input signal is active low when COM1 and COM2 are connected to 24V, and active high when COM1 and COM2 are connected to 0V.

2.6.3 Output interface definition

DO1-DO8 are 8-way relay output mode refer to the following figure:

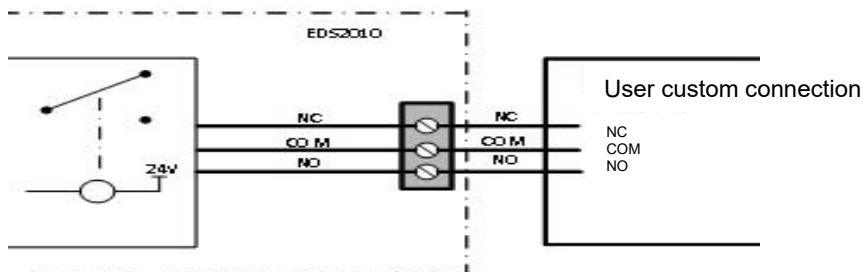

DO9-DO16 are 8-way transistor output mode refer to the following figure:

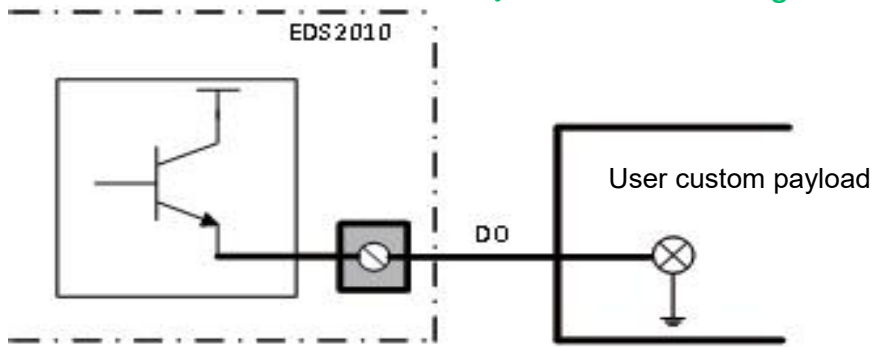

3 Preparation for software installation

3.1 Self-hosted recommended configuration

CPU	Inter i5 1.6GHz (4 cores) and above
Memory	8GB and above
Storage Devices	120G hard drive and above
Network Card	2×10/100/1000 Gigabit NIC
USB	4×USB3.0 4×USB2.0
Show	Support both HDMI or VGA interface
Operating System	Genuine Windows 10 (64-bit Professional Edition) / Genuine Windows 7 (64-bit Flagship Edition)

3.2 Installation Software

3.2.1 Installation of cutting software

1) Right-click on the software installation package and select Open or Run as Administrator.



2) Follow the prompts and click Next.



3) The installation environment. The system will automatically identify whether the installation environment is complete. It is not recommended to select it by yourself, you can directly click Next.

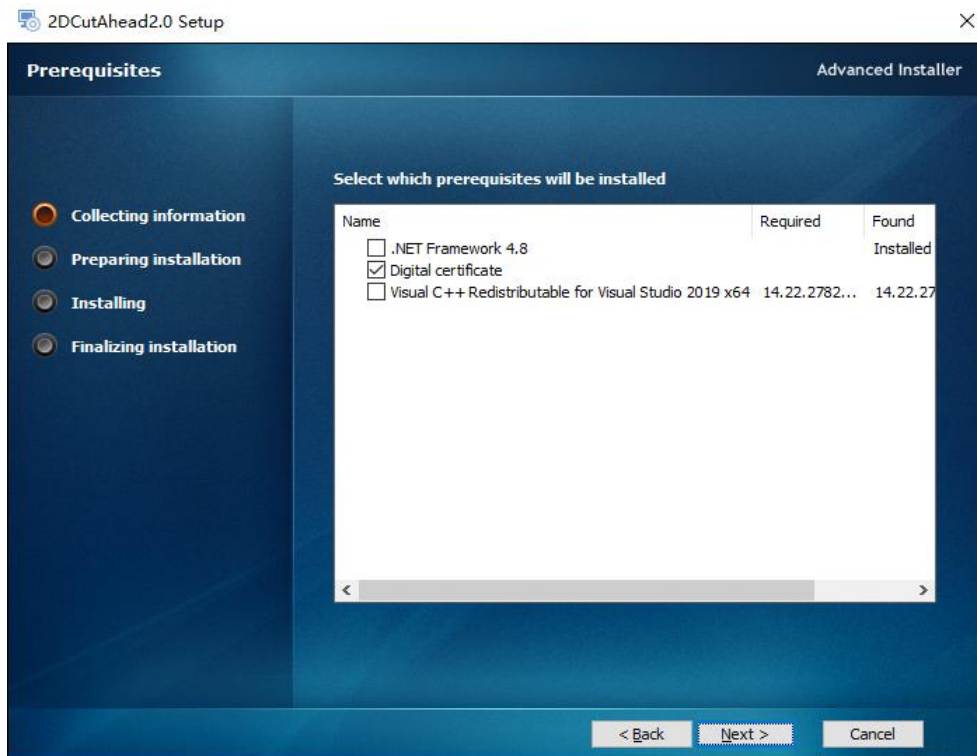

4) Select the installation path, the default installation path is C:/HMI, it is not recommended to change it, you can directly click Install.

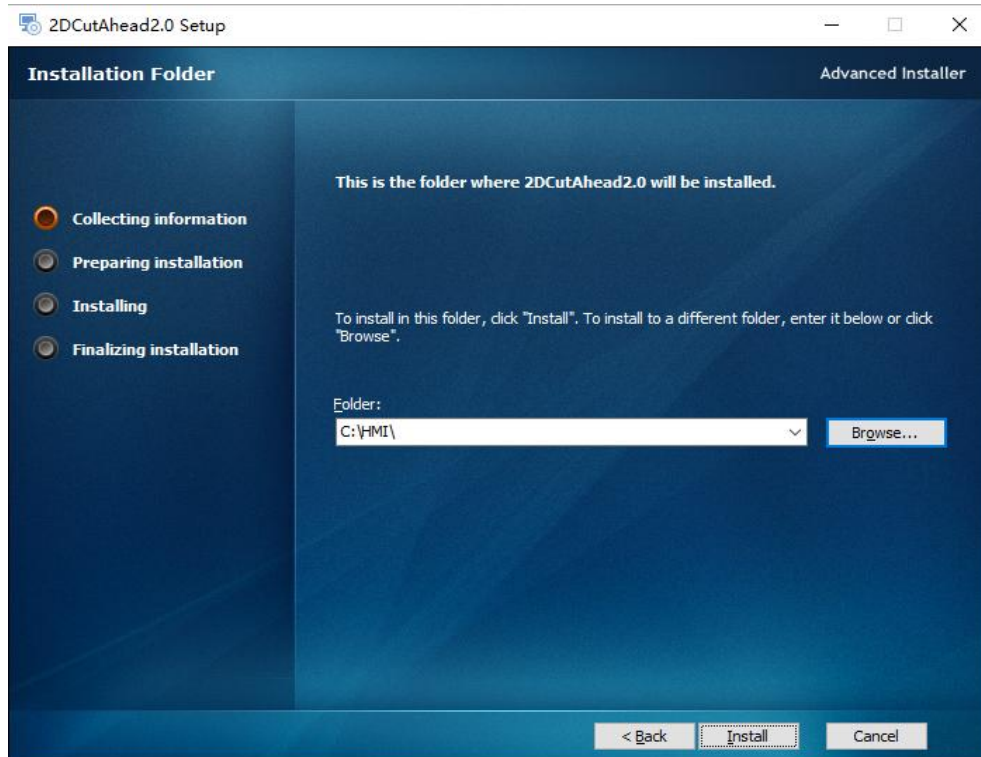

5) After the software installation is complete. Wait for the update of the underlying firmware, this step will take a long time, please be patient.

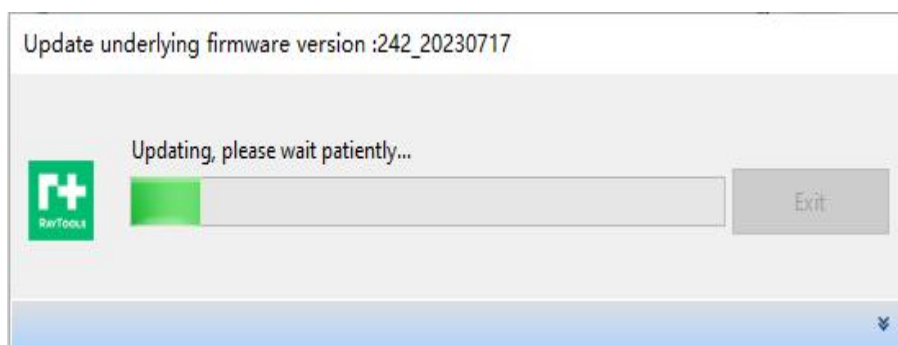

3.2.2 Filter by actual configuration

7) System: XC3000S; Keyword 1: EDS3000. Keyword 2: Pulse-dir drive or COE drive according to the actual configuration.

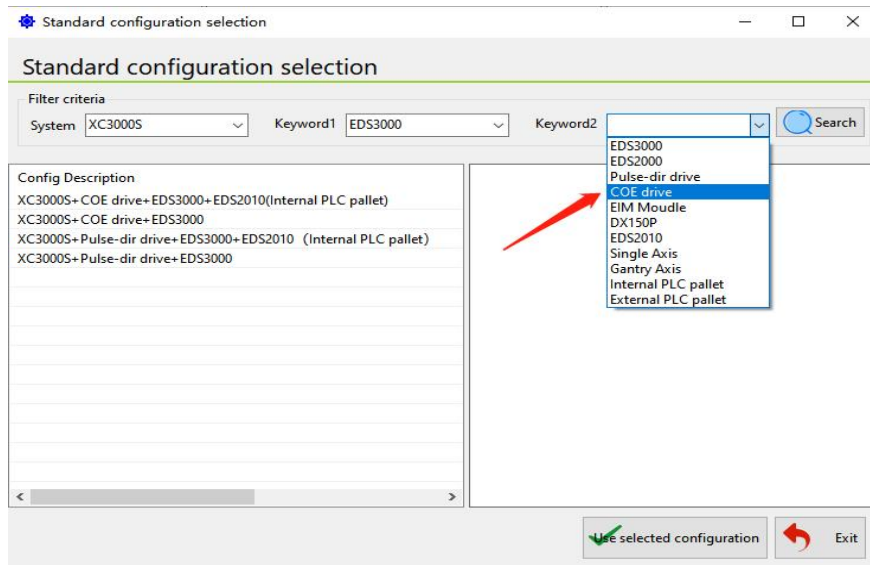

8) Check the standard configuration in the configuration description, after which click Use selected config.

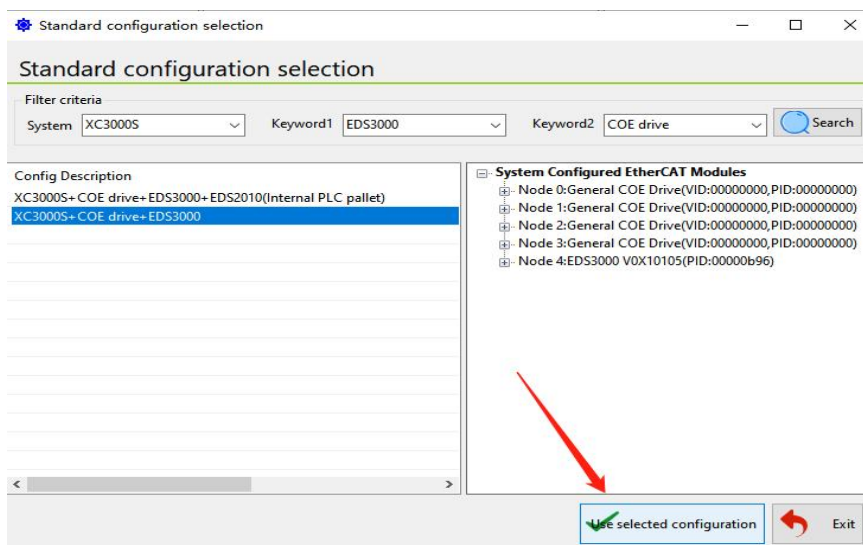

3.2.3 Software parameters setting

Set the parameters of X, Y, and Z-axis, Pitch compensation, Verticality correction, Laser head, Laser Device, Assist gas, Dust removal valve, Alarm, Button, Pallet changer, Lubrication and other parameters according to the actual situation of the machine. Please refer to Chapter 5 "Platform Configuration Tools" for details.

3.2.4 Save and activate the master

9) Click Save and then click Restart Controller to update the master module configuration information.

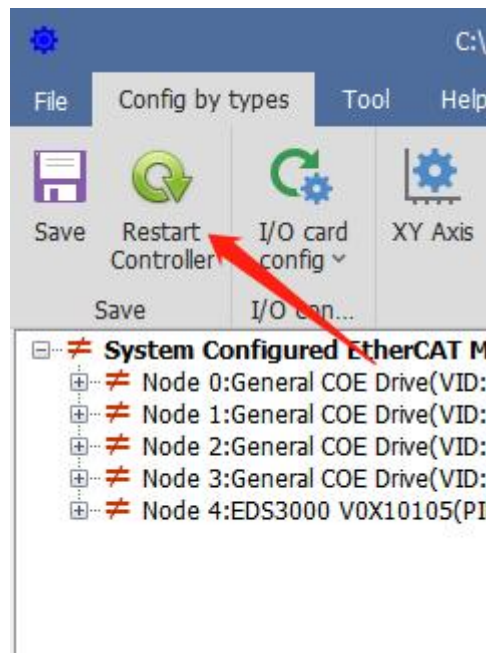

10) Wait for the controller to restart, then click Exit config. Start HMI to open the cutting software.

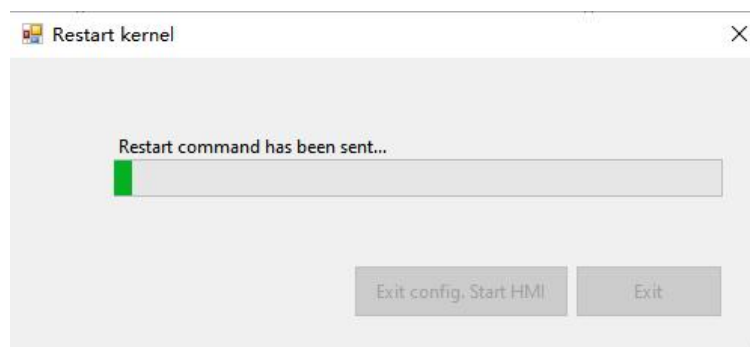

3.2.5 Registration is required to open the process, you can register through the mobile WeChat applets.

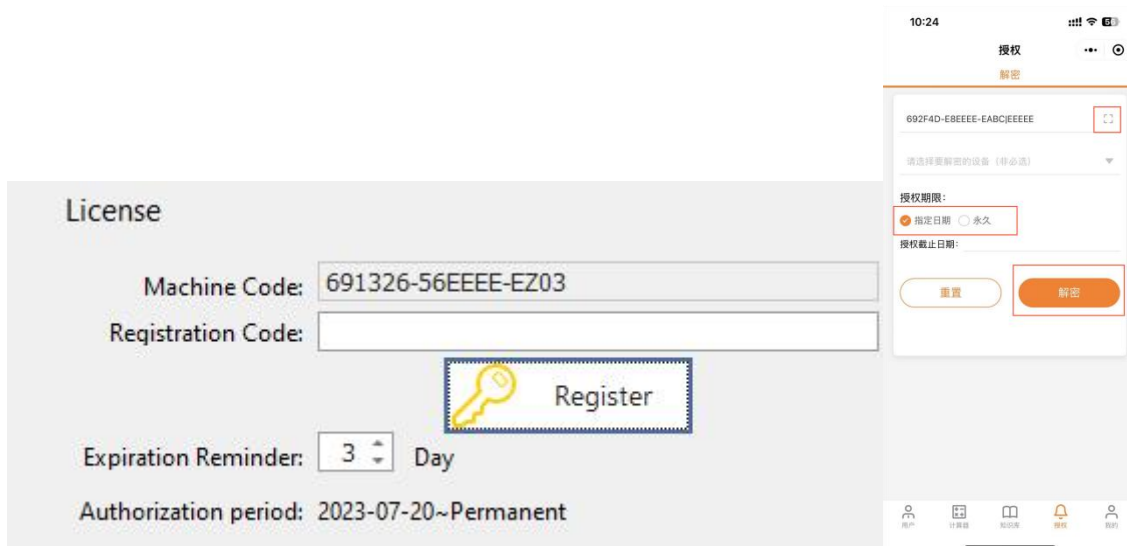

3.2.6 Use XC3000S software

After opening the software, import the graphics to be processed and configure the process parameters for processing. Please refer to the latest "XC3000S Series Laser Cutting System User Manual" for details.

3.3 Software Licensing

1) Open the software and click the "?" at the top right corner of the software page. 2) Open the WeChat applet "KIC Cloud", log in, click Authorize, then click Swipe icon and scan the QR code of the software, as shown in the figure below:

3) After scanning, the machine code and dog number will appear, and then select the "license expiration

date".

4) Click "Decrypt".

5) Copy the "registration code" in the interface into software registration code box.

6) Click "Register", you can see that the authorization period on the software has changed, as shown in the following figure:

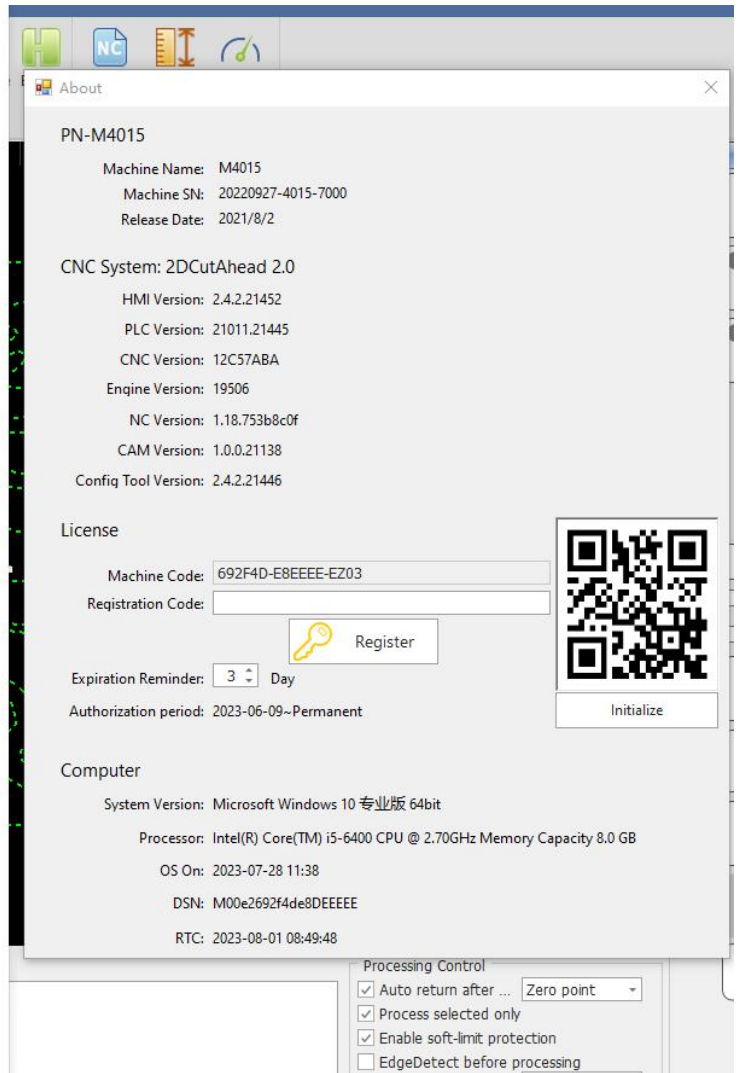

4 Machine tool commissioning

After installation, a password 4006701510 is required to enter the configuration tool. Then you can select the category configuration in the menu bar, you will see the Parameter button. Click the corresponding parameter button, the parameter dialogue box will show to modify the parameter. After changing the parameter and checking it, restart the software then the changed parameter will take effect.

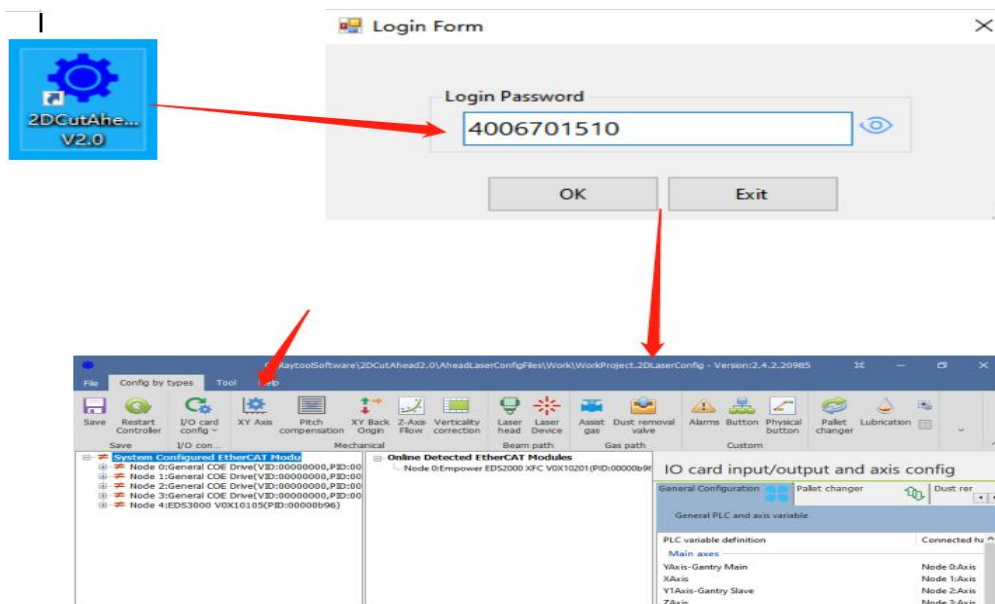

4.1 Set the parameters in the parameter screen according to the actual configuration

1) XY axis mechanical parameters and hardware configuration

XY axis mechanical parameters: Encoder pulse count, Pitch

XY axis point and port config: XY hard limit, XY axis servo axis port, XY soft limit.

The screenshot displays four configuration panels for the X and Y axes:

- X axis mechanical parameter:** Encoder pulse count (10000), Motor direction (Reverse), Pitch (36mm), Backlash compensation (0mm), Max speed (60m/min), Max following offset (60mm), Max acceleration (10000mm/s²).
- X axis point and port config:** Positive hard limit signal (Node 4DI_3), Zero signal (Node 4DI_2), Negative hard limit signal (Node 4DI_1), Servo axis (Node 1-Axis), Soft limit range (-2 to 600 mm).
- Y-axis mechanical parameter:** Encoder pulse count (10000), Motor direction (Reverse), Pitch (36mm), Backlash compensation (0mm), Max speed (60m/min), Max following offset (60mm), Max acceleration (10000mm/s²).
- Y axis point and port config:** Positive hard limit signal (Node 4DI_6), Zero signal (Node 4DI_5), Negative hard limit signal (Node 4DI_4), Servo axis (Node 0-Axis), Soft limit range (-2 to 600 mm).

Global settings include: Sync X parameters to Y1, Sync Y parameters to X1, Separate set (selected), All limits NO, All limits NC, Separate set (selected).

2) XY axis return to origin parameter

XY axis return to origin parameters: Return origin mode, Return origin direction and type, Zero signal, Aft back set coordinate.

The 'Return to origin' screen is divided into two sections:

- X axis:** Return origin... (Increment), Return origin direct... (Negative, Limit), Return orig... (1.8m/min), back dis... (5mm), Aft back set coordi... (0mm), Absolute zero of... (0mm).
- Y axis:** Return origin... (Increment), Return origin directi... (Negative, Zero), Return orig... (1.8m/min), back dis... (5mm), Aft back set coordi... (0mm), Absolute zero of... (0mm).

3) Z-axis parameters

Servo parameters: Pulse number, Pitch

Homing parameters: Homing mode, Return origin direction and type, Zero signal, Zero signal logic, Coordinate aft backward set

Axis point and port config: Servo axis, positive and negative hard limit, soft limit

Z-Axis Flow

Servo Parameter

- Motor direction: Positive *
- Pulse number: 10000 *
- Pitch: 10mm *
- Max follow-up offset: 5mm
- Speed unit of Drive: pulse/s *
- Speed loop feedforwa...: 0.01

Return to Origin Parameter

- Homing mode: Incremental Mode
- Return origin direction a...: Positive, Limit
- Return origin speed: 0.9m/min
- Back Distance: 5mm
- Coordinate aft backward...: 0
- Origin point offset com...: 0mm

axis point and port config

- Servo axis: Node 3:Axis
- Positive hard limit...: Node 4:DI_9, NO
- Negative hard lim...: Node 4:DI_7, NO
- Soft limit range: -55 ~ 2 mm
- Brake output: Not used

4) Laser head

Laser head parameters: Brand, Model, Focus control mode, Height sensor type, Height sensor signal port.

Laser head

Brand: Raytools

Model: BS20K

Focus control mode: BS Smart Focus

Height sensor type: EDS On Board

Height sensor signal port: Node 4:Height Sensor Capacitan

Focus adjmt: []

Limit Co

Soft Limit Ran

- Close Focus Head
- Close Cavity Temp
- Close Cavity Gas P
- Close WIFI Alarm

5) Laser Device

Laser brands and parameters: Laser brand, Laser power, Frequency

Laser Brand and Parameter		
Laser brand:	Raycus	▼
Laser power:	1500	W ▼
Frequency:	5000	Hz ▼
Voltage of max power:	10	v ▼
Feedback voltage of max power:	10	v ▼
Analog output delay	0	ms ▼
FlyCut laser on delay	0	ms ▼
FlyCut laser off delay	0	ms ▼

6) Gas interface common settings

Gas pressure control: default can be, change if there are special needs.

Gas process control: default can be, change if there are special needs.

Pressure standard: default can be, change if there are special needs.

Gas control: default can be, change if there are special needs.

7) Physical button

Control panel: Start signal logic, Pause signal logic, Reset signal logic, Emergency stop alarm logic

Control Panel		
Start signal logic	Node 4:DI_14	NO ▼
Pause signal logic	Node 4:DI_17	NO ▼
Reset signal logic	Not used	NO ▼
Emergency stop alarm...	Node 4:DI_13	NC ▼

4.2 Test if each axis limit is effective

Note: The motor should be in the no enable state throughout this step!

1) Enter the HMI software interface, File - Diagnostic Tool- IO Monitor

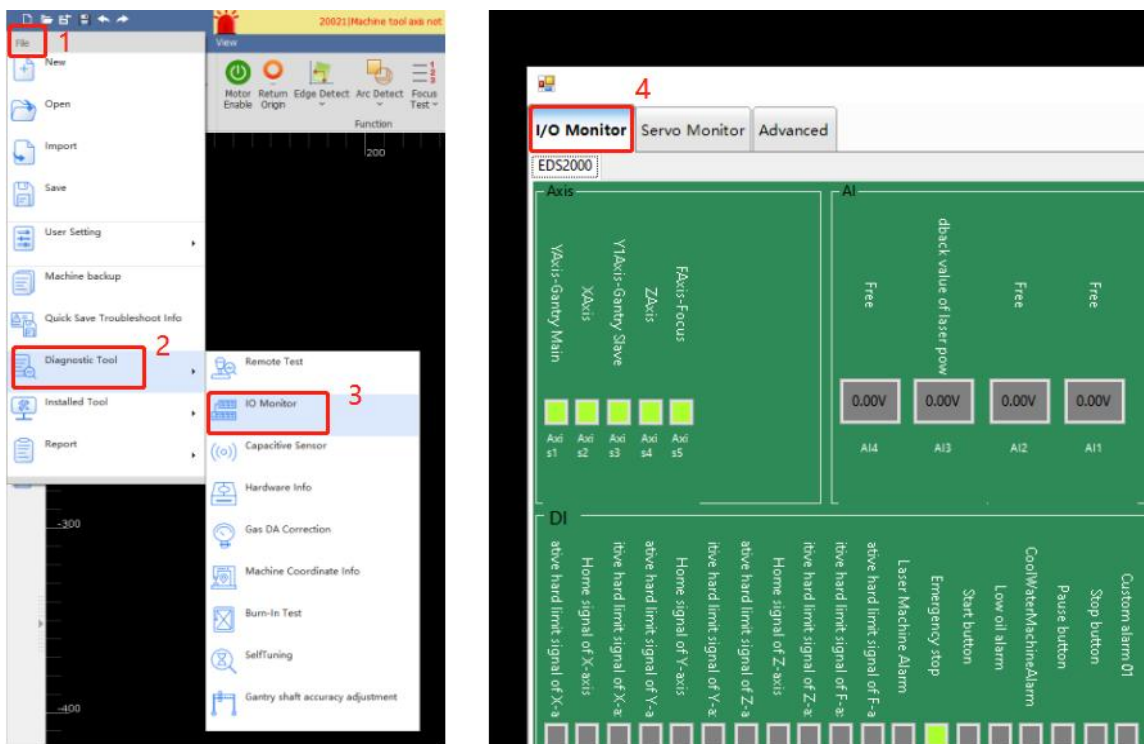

2) Trigger the limit switch and observe whether the corresponding point position in the monitoring interface has changed



3) Verify the panel buttons for energy stop, each axis limit and zero switch, and start/pause in turn until each input is confirmed to be normal.

4.3 Zeroing the machine and adjusting the servo gain

1) Click CNC in the menu bar, click Return origin, and click OK in the pop-up window that appears.

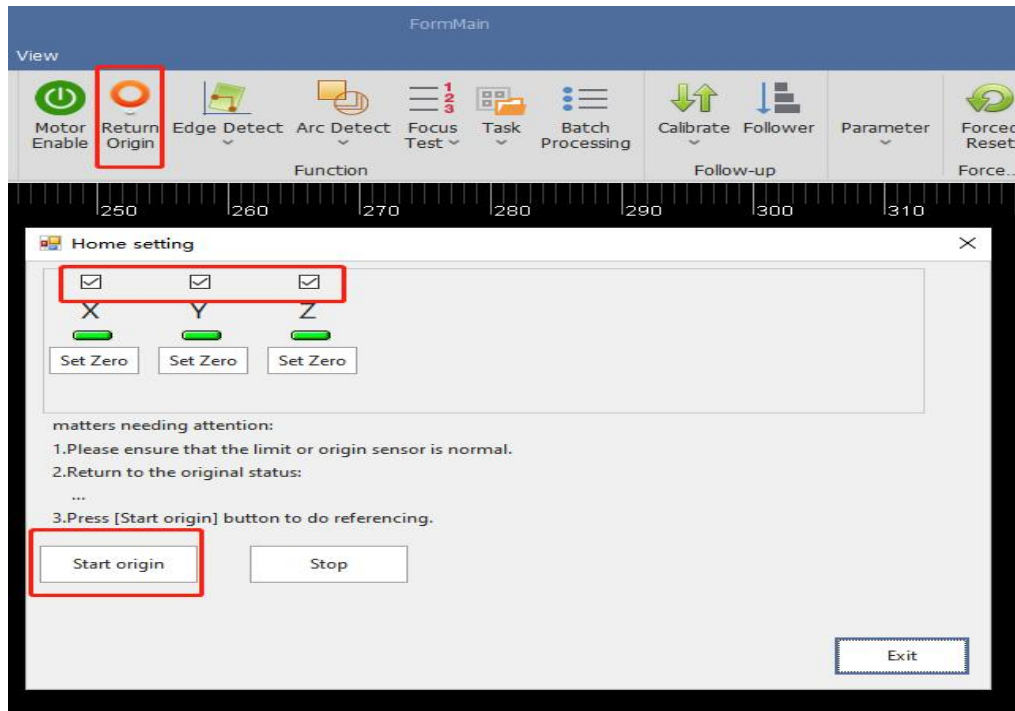

Draw a garden of about 30mm, turn on error detection, and then adjust the cutting speed to 30m/min up or down in the process. Then select the drawing and click on the empty walk.

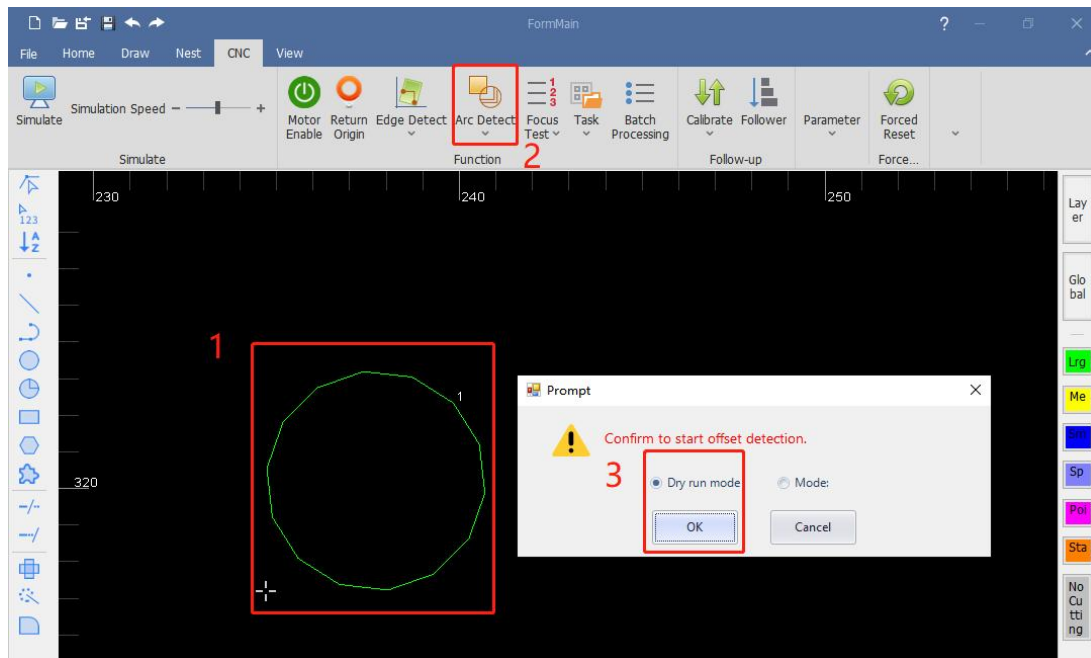

After the motion is completed, the system draws the position of the encoder feedback on the software and the servo error can be seen using the measurement. This error can be used as the basis for adjusting the servo parameters.

5 Platform Configuration Tools

After installation, a password is required to enter the configuration tool, which is 4006701510.

5.1 Interface Introduction

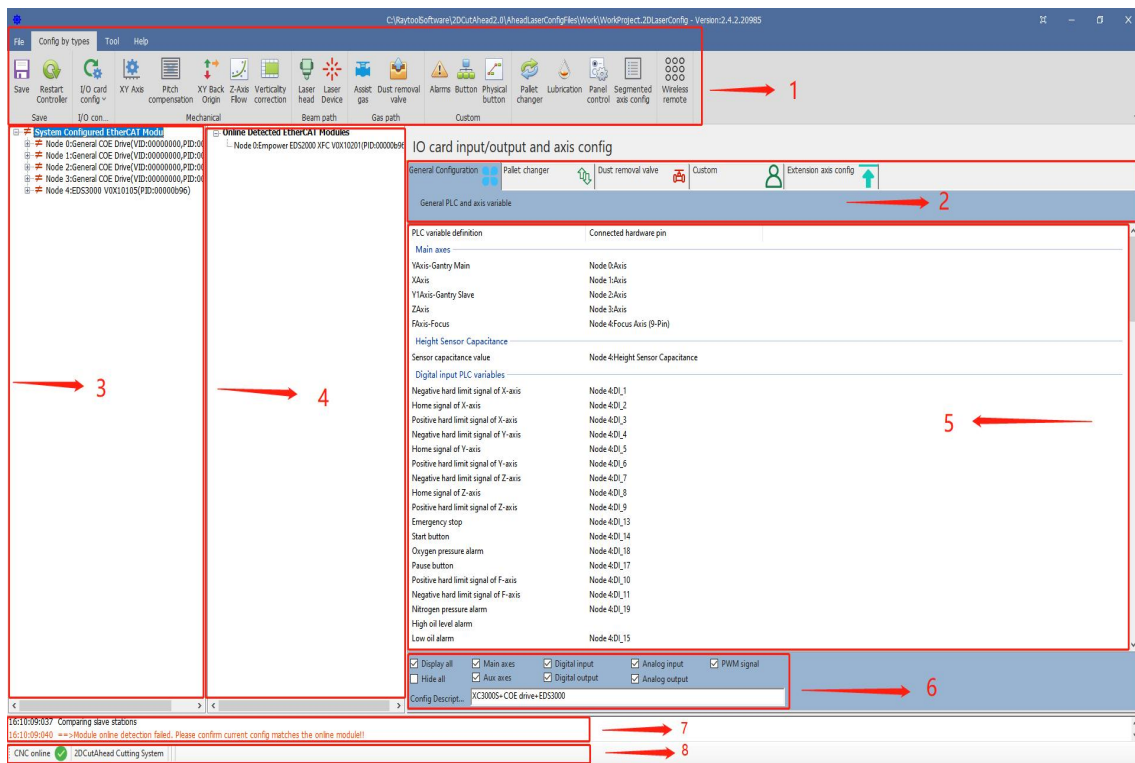

1: Menu bar area; 2: PLC Variable Classification Area; 3: Current configuration area; 4: Online module area; 5: PLC Variable Area; 6: PLC Variable Pin Selection; 7: Journal area; 8: Status area

5.1.1 Menu bar area

Including: File, category configuration, Tool and Help

File



Save button: Save the current configuration file.



Restart kernel: Activate current configuration Reads the configuration from the kernel module and import it into the current configuration area Activate current configuration

Category Configuration

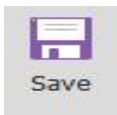

Save button: Save the current configuration file.



Restart Controller: Activate the current configuration reads the configuration from the kernel module and import it into the current configuration area activates the current configuration.



Online Slave Check: Check if the connected modules are the same as the modules in the configuration area.



Import Standard Config: Import the standard configuration file preset by the system.



Activation history: View the history of activations and select the history to load into the current configuration area.

◆ XY axis mechanical parameters and hardware configuration

XY axis mechanical parameters and hardware configuration, as shown in the figure below. Please refer to the 7.4.1 for details.

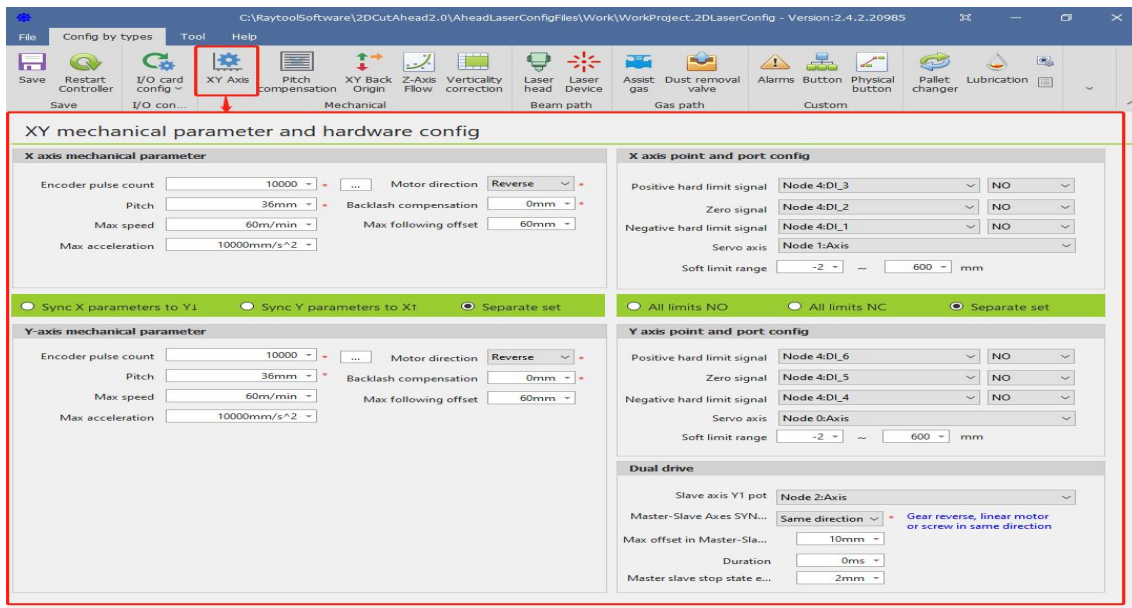

◆ Pitch compensation (the parameters from the interferometer are imported, and the error is inverted according to the actual situation. The import file format rtl, pos, lin) is shown below. Please refer to the 7.4.2 for details.

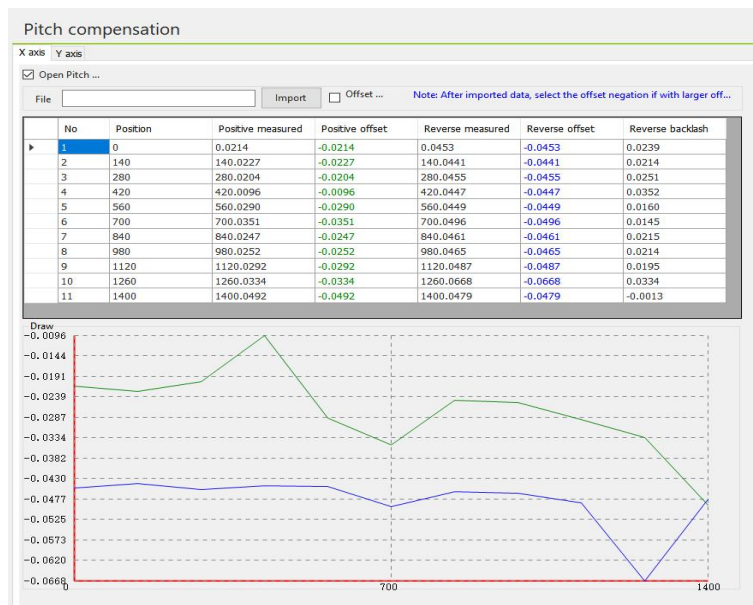

◆ XY Back origin

XY Back origin parameter, as shown in the figure below. Please refer to the 7.4.3 for details.

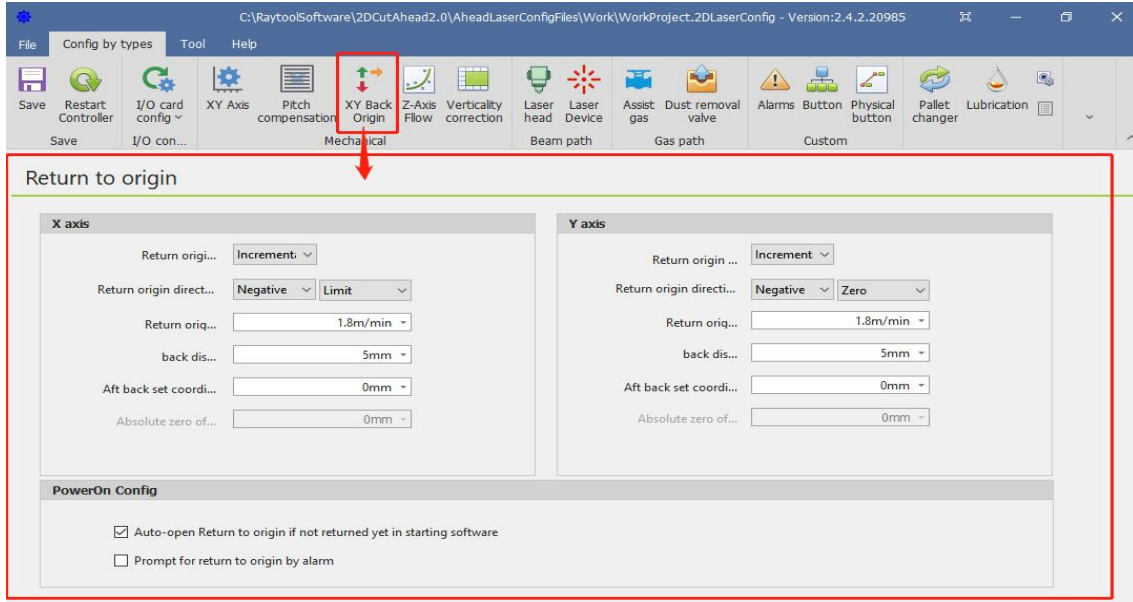

◆ Z-axis follow

The Z-axis follow parameters are shown in the figure below. Please refer to the 7.4.4 for details.

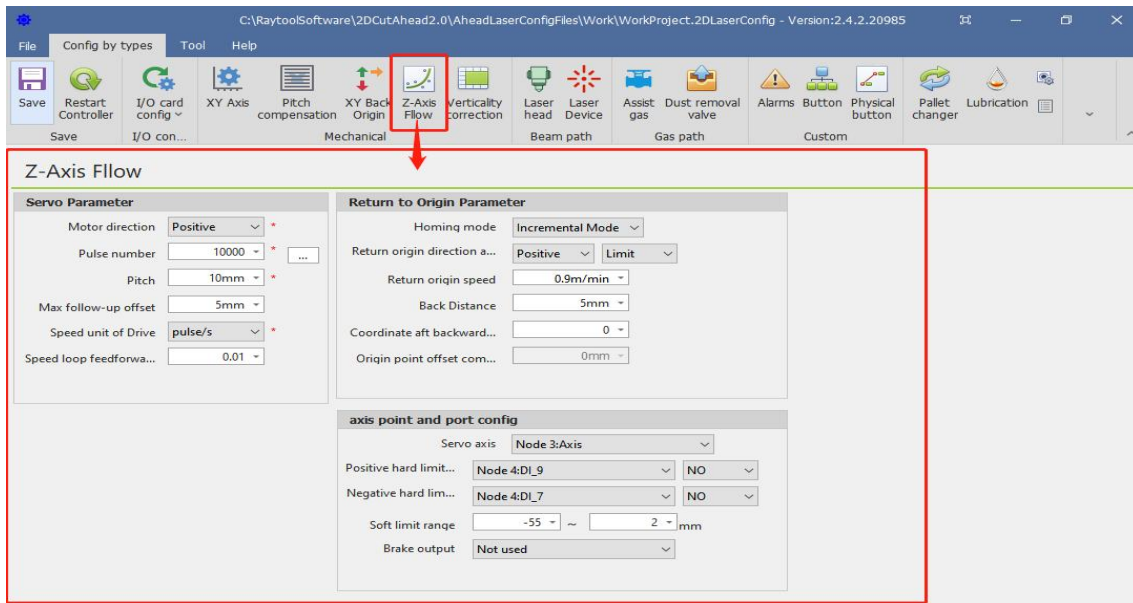

◆ Verticality correction

Verticality correction, as shown in the figure below. Please refer to the 7.4.5 for details.

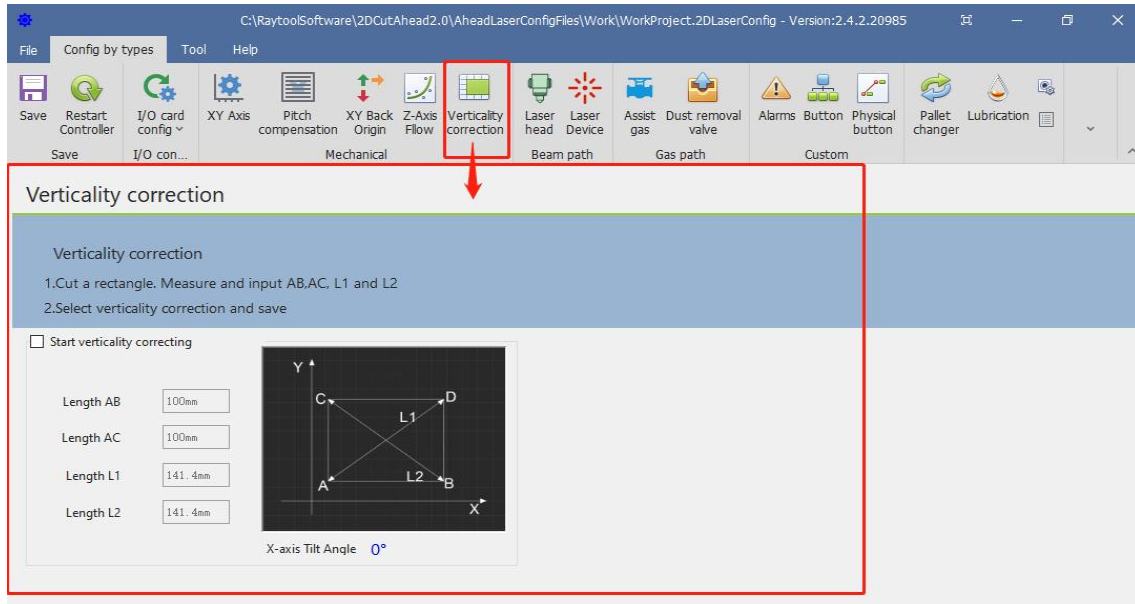

◆ Laser head

Laser head parameters, as shown in the following figure. Please refer to the 7.4.6 for details.

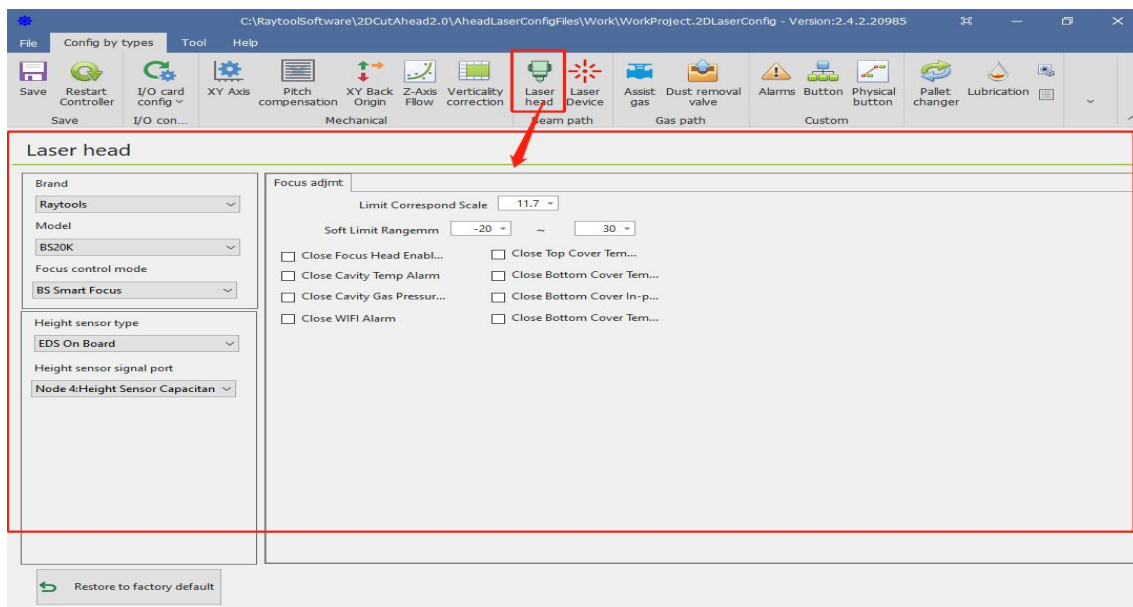

◆ Laser Device

Laser Device parameters, as shown in the following figure. Please refer to the 7.4.7 for details.

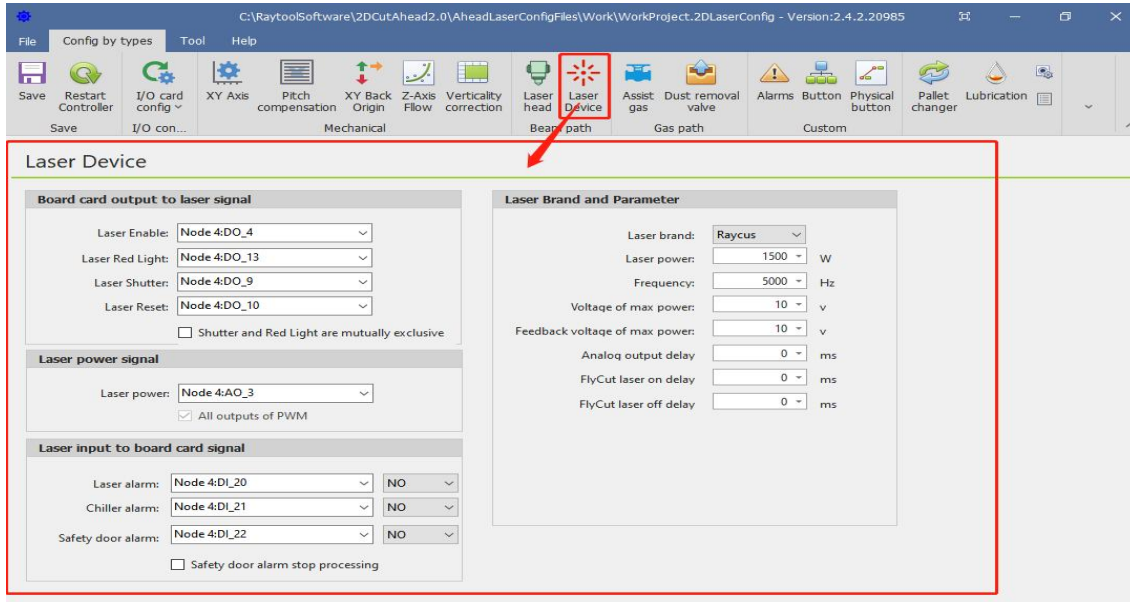

◆ Assist gases

Assist gas cell valve and analog output settings, as shown below. Please refer to the 7.4.8 for details.

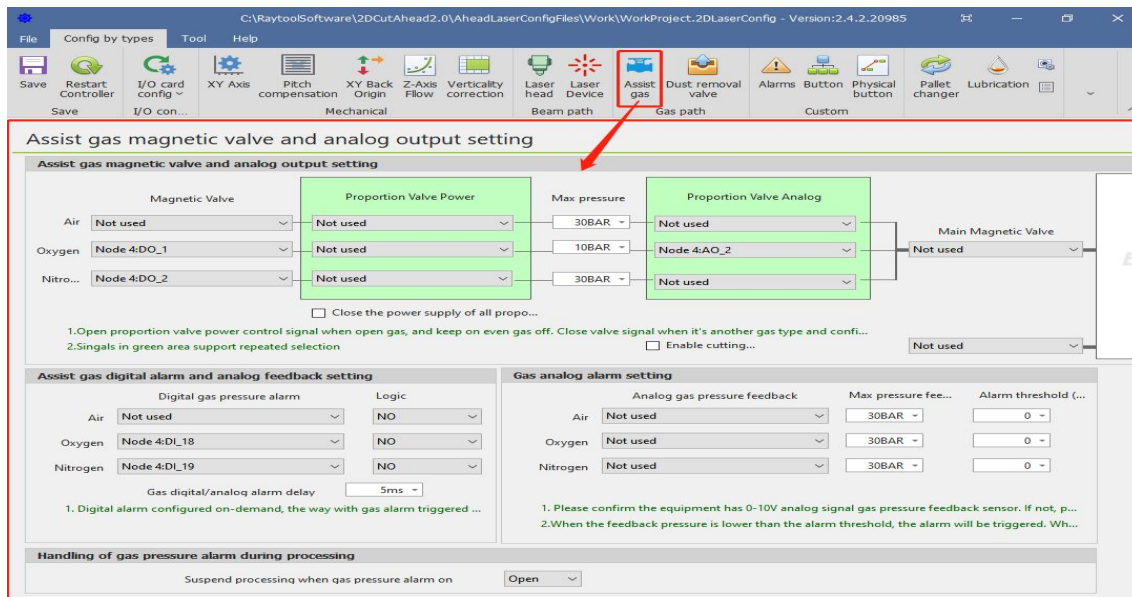

◆ Dust removal valve

Dust removal valve parameters, as shown in the following figure. Please refer to the 7.4.9 for details.

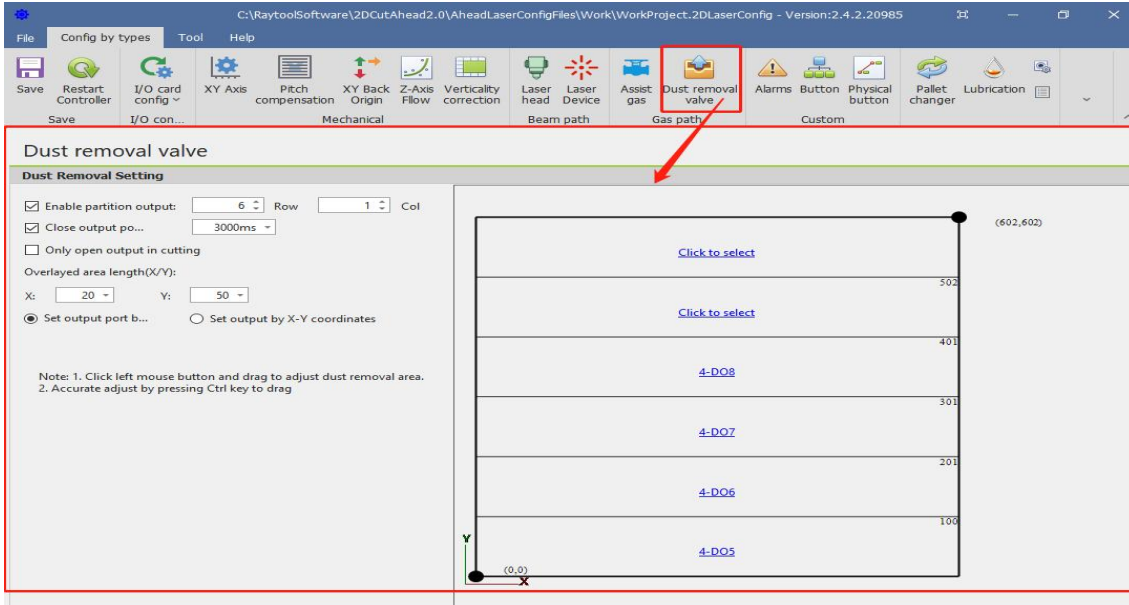

◆ Alarm

1-16 custom alarm settings, as shown below. Please refer to the 7.4.10 for details.

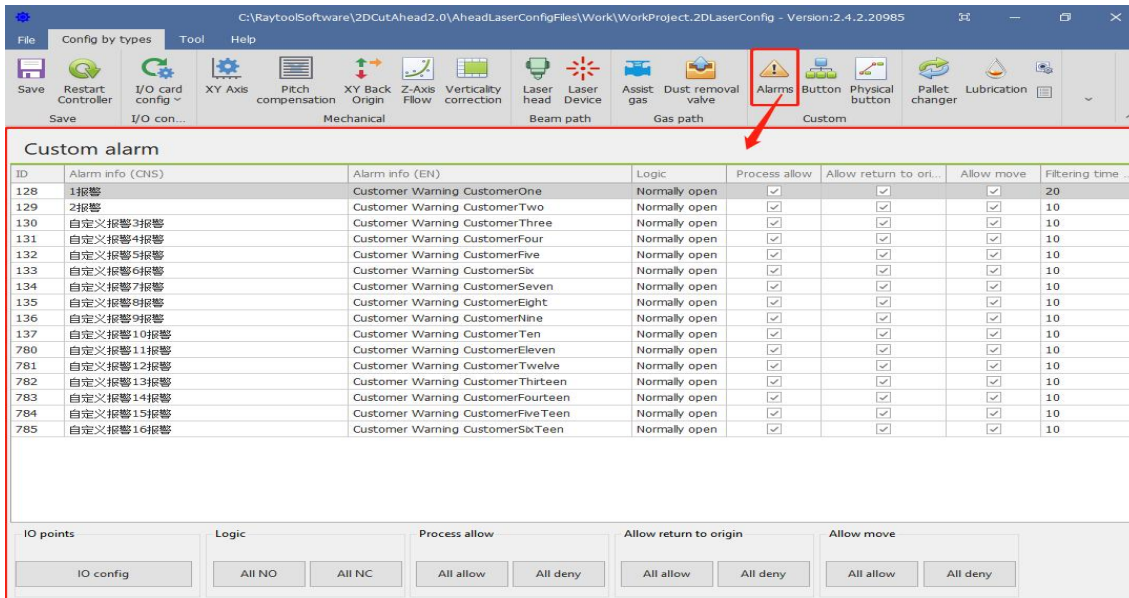

◆ Button

Buttons are divided into custom buttons and physical buttons.

Custom button, as shown in the following figure. Please refer to the 7.4.11 for details.

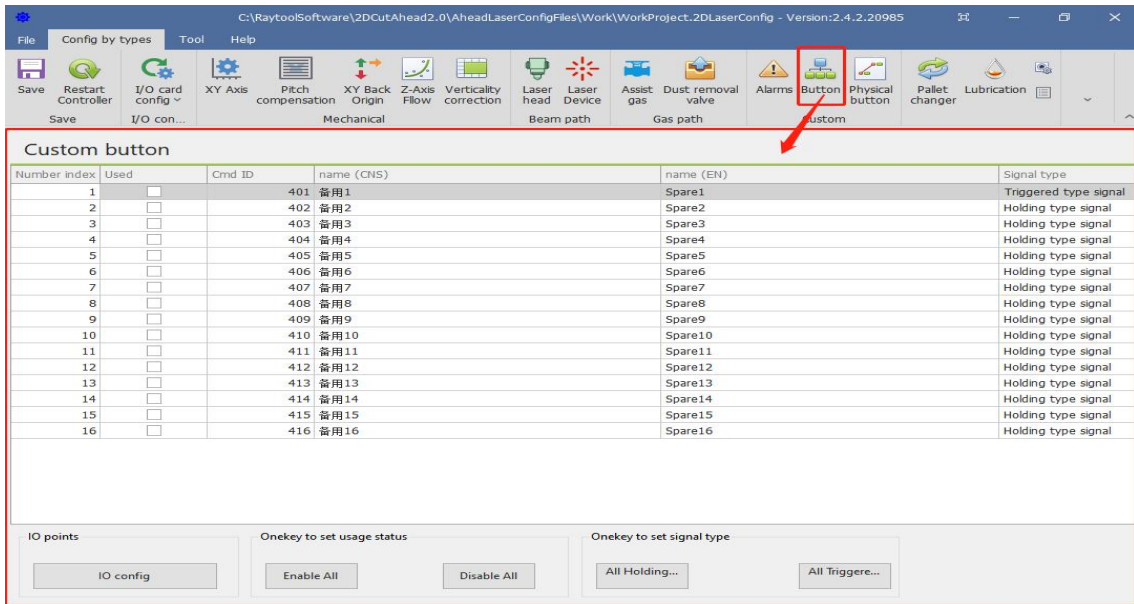

Physical button, as shown in the following figure. Please refer to the 7.4.12 for details.

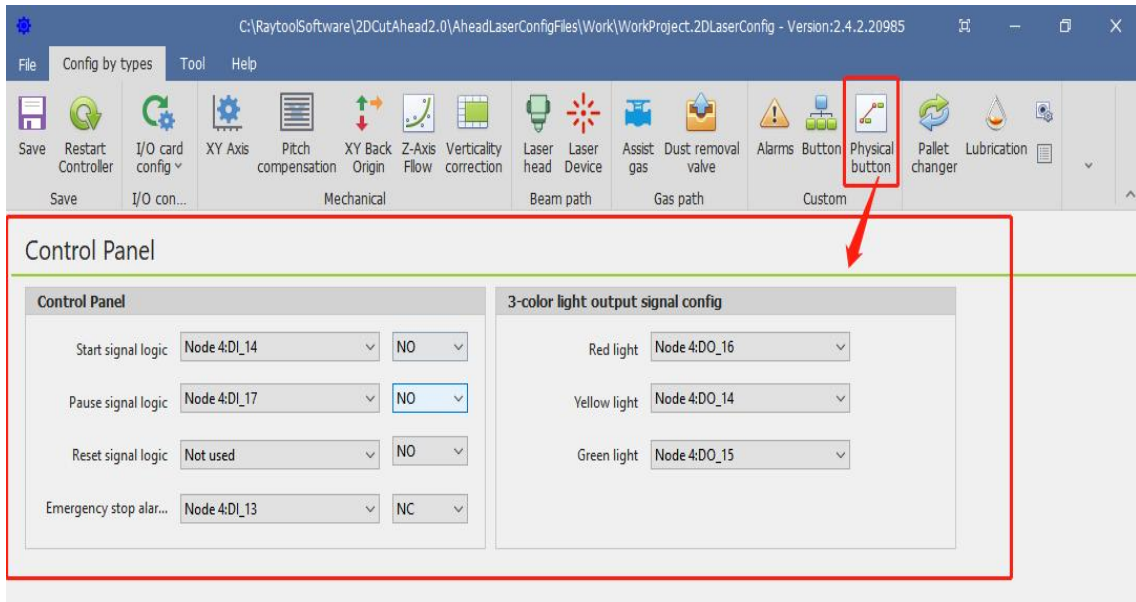

System Commissioning Manual

◆ Pallet changer

Pallet changer parameters, as shown in the following figure. Please refer to the 7.4.13 for details.

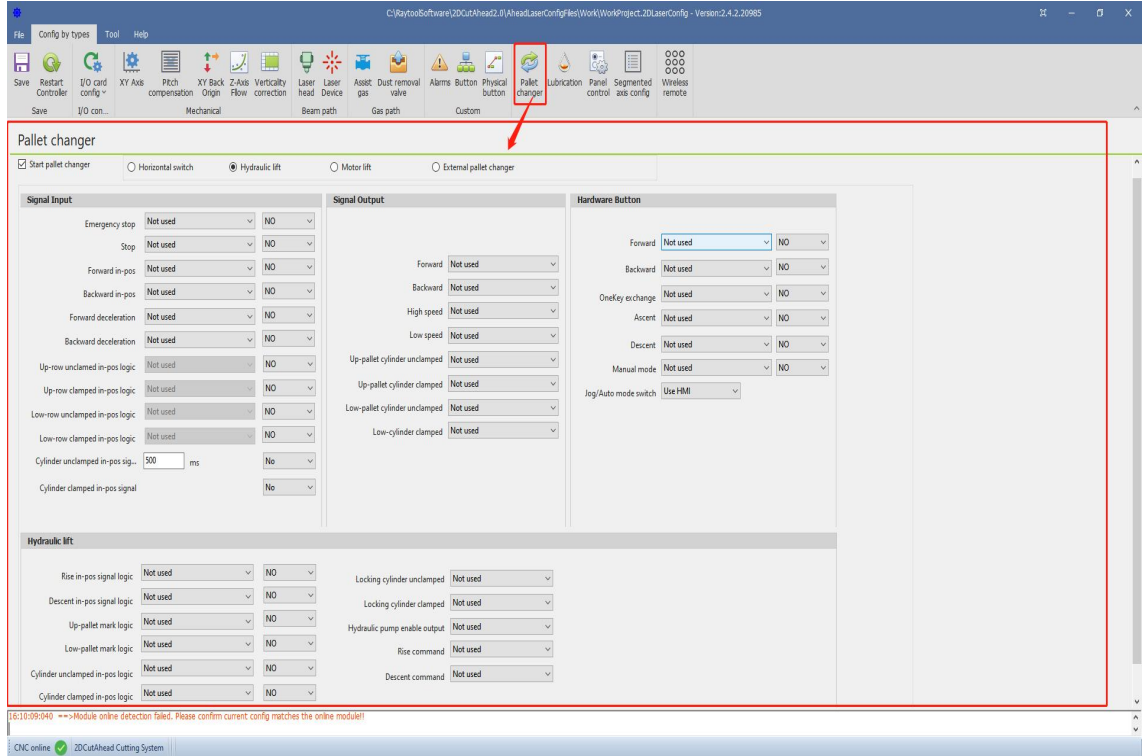

◆ Lubrication

Lubrication parameters, as shown in the figure below. Please refer to the 7.4.14 for details.

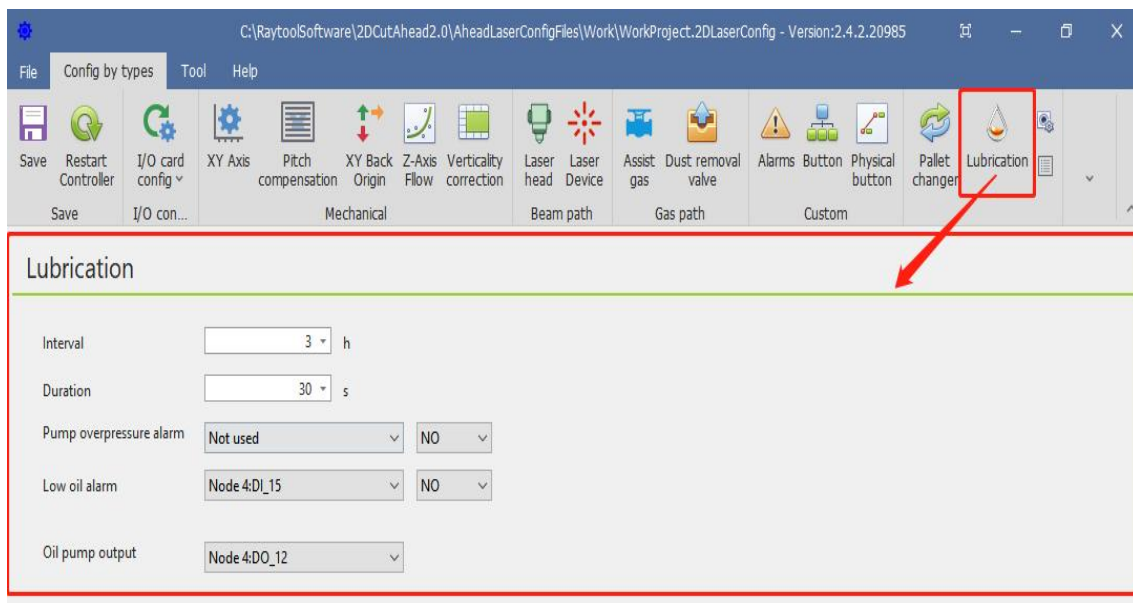

◆ Panel Control

1. Select the software interface display according to the display, as shown in the following figure:

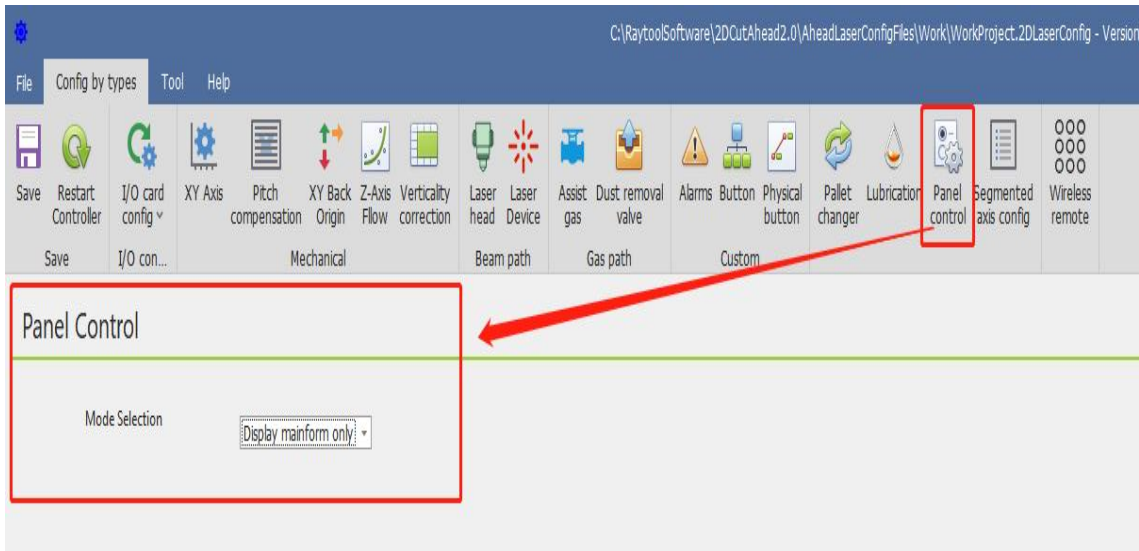

2. Set Mainform height of the main interface, Number of camera, Camera brand, and Display monitor panel:

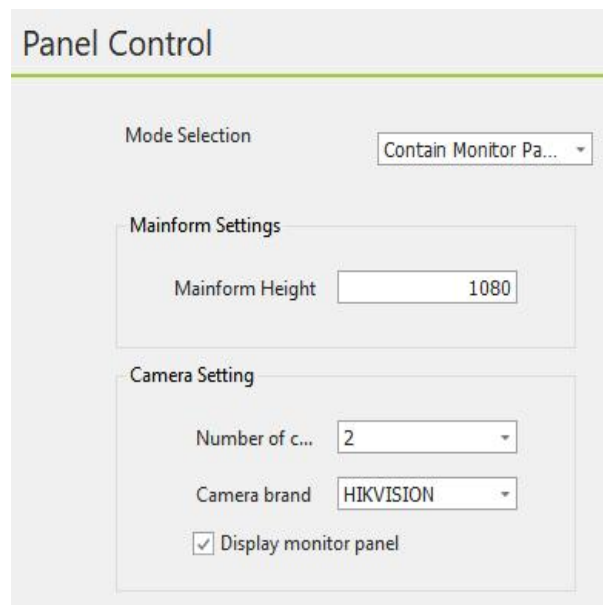

System Commissioning Manual

3. Open the software and right-click on an empty space in the monitoring panel.



4. Setting the camera's user name, password, IP, and port number

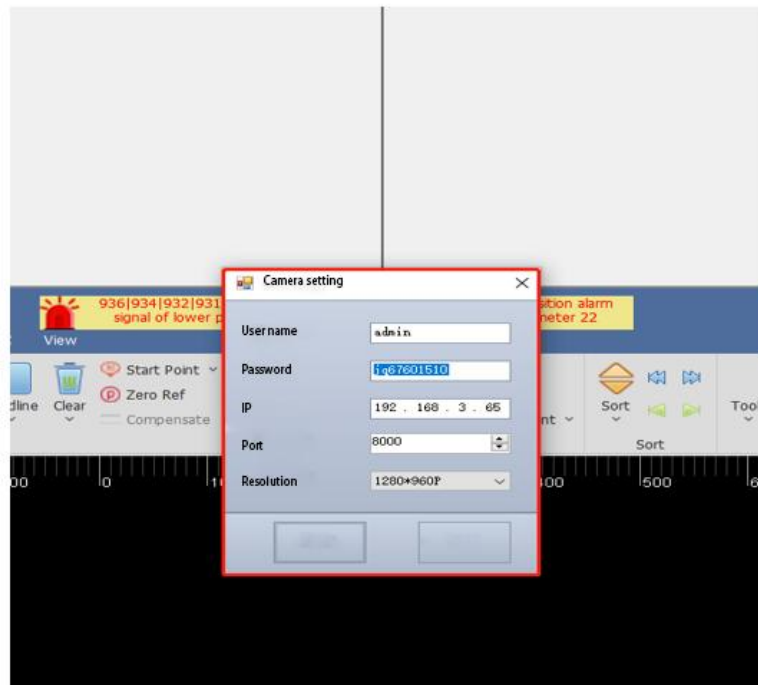

◆ Segmented axis configuration

Mechanical parameters and hardware configurations for the three segmented axis parameters C, V and B can be configured as shown below. Please refer to the 7.4.15 for details.

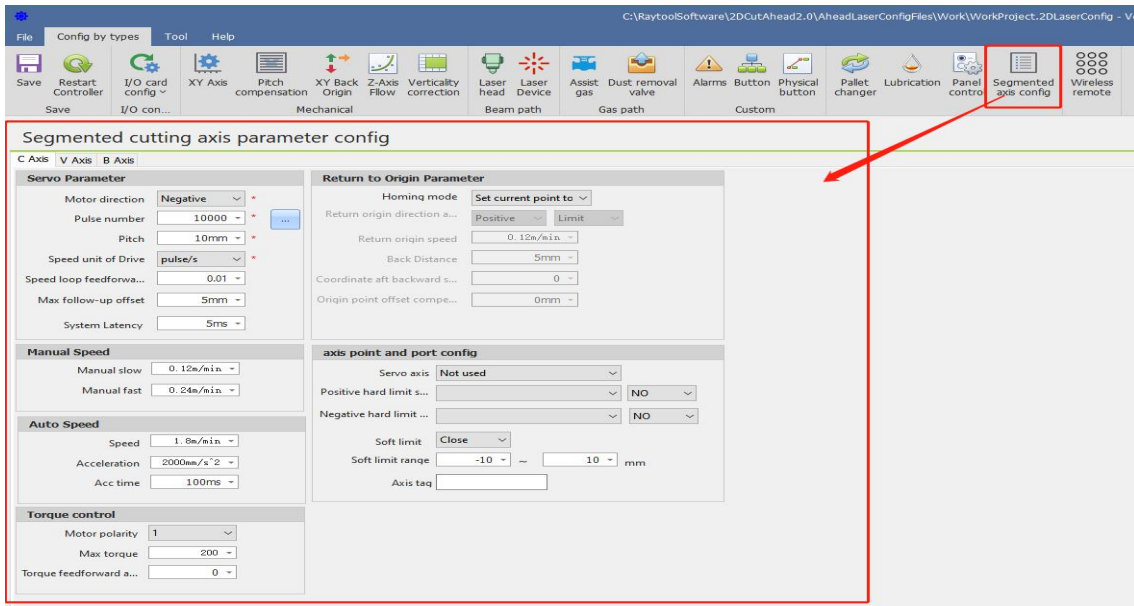

◆ Handle configuration

You can configure the functions of K1~K4 and Fn+K1~K4 keys in the wireless handle, and you can also change the up/down/left/right axis motorized direction, as shown in the following figure.

System Commissioning Manual

C:\RaytoolSoftware\2DCutAhead2.0\AheadLaserConfigFiles\Work\WorkProject.2DLaserConfig - Version:2.242.21030.21370

File Config by types Tool Help

Save Restart Controller I/O card config ~ XY Axis Pitch compensation XY Back Origin Z-Axis Flow Verticality correction Laser head Laser Device Assist gas Dust removal valve Alarms Button Physical button Pallet changer Lubrication Panel control Segmented axis config **Wireless remote**

Save I/O con... Mechanical Beam path Gas path Custom

Remote config

Click to select		Click to select	
Click to select		Click to select	
Start	Pause	Continue	Stop
Blow	Follow	Shutter	Aiming
BKP LOC	Back	Forward	Laser
Edge Detect	Frame	Dry Run	Fn
W+	Y(+)	Z ↑	CalSet(Fn)
X(-)	Home	X(+)	Fast
W-	Y(-)	Z ↓	Step
Click to select		Click to select	
Click to select		Click to select	

Axis jog setting

Switch [left-right] axis jog direction

Switch [up-down] axis jog direction

Switch [up down - left_right] axis jog direction

Tip:

Click to select Triggered when pressed alone

Click to select Fn key + press to trigger

After saving config file, restart HMI to make parameters effective

Tools



: Update firmware

Update to the main control module firmware, the update will overwrite the original program and configuration information, then re-activate the configuration.



: Firmware authorization

For kernel master authorization, if not authorized, contact our after-sales professionals.



: Advanced option, please refer to the 7.4.16 for details.

Language: Simplified Chinese, Traditional Chinese and English are available.

Advanced option: Please do not change the check box, if you need to change, please contact us.



: Machine backup

Back up the machine configuration parameters, process parameters, and system parameters.



: Machine restore

Restore the machine configuration parameters, process parameters, and system parameters.

Help



: About

Copyright notice and tips for this software.





: Information

Set the machine name, machine model, machine number and machine factory date.

5.1.2 PLC Variable Classification Area

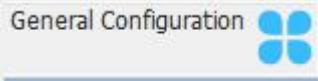
By selecting different tabs, the variables displayed in the PLC variables area will follow the changes including: Flat General Configuration, Switchboard, Dust Extraction Valve, Custom

 General Configuration. This tab contains: cutting motion axes, height sensors and PLC variables such as capacitance value, limit signal, button input, nitrogen and oxygen pressure alarm, and start/pause / emergency stop /reset button can be selected through the PLC variable pin selection area.

 Pallet changer. This tab contains all the variables related to the switch.

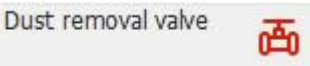
 Dust removal valve. This tab contains the 32-way dust partition variables.

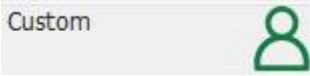
 Custom. This tab contains custom alarms, user custom IO inputs.

User custom I outputs, 16 of each, 48 variables in total.

Among them, custom alarm name and NO/NC can be set in the HMI alarm; user custom IO output can be customized in the HMI output point for hold or trigger type.

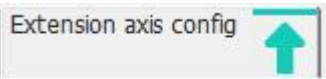
 Extension axis config. This tab contains the PLC defined variable IO input 10 positive and 10 negative limits and 10 extension axes.

5.1.3 Current configuration area

You can view the current profile's point link definition and connection order in this area.

You can also add, insert, change or delete slave and point link information; Please refer to section 5.3 for details.

5.1.4 Online Module Area

This area will only appear when the configuration of the current configuration area is different from the actual configuration, at which time the module online detection button will also have a red flashing alert.

5.1.5 PLC Variable Area

The PLC Variables area lists all PLC variables, and point link information.

5.1.6 PLC Variable Pin Selection

You can select variables by variable type, and find the required PLC variables faster.

5.1.7 Journal area

The log area displays important information such as the status of the connection to the master, whether the activation was successful, etc.

5.1.8 Status Area

The status area shows whether the CNC master is offline, whether the configuration platform is pipe cut or flat, the version number of the XStudio compilation, the Information such as whether the CCD pin is supported.

5.2 Configure and change points

5.2.1 Operation on slave stations

Add:

1) Right-click - Append EtherCAT Node - select the slave to be added.

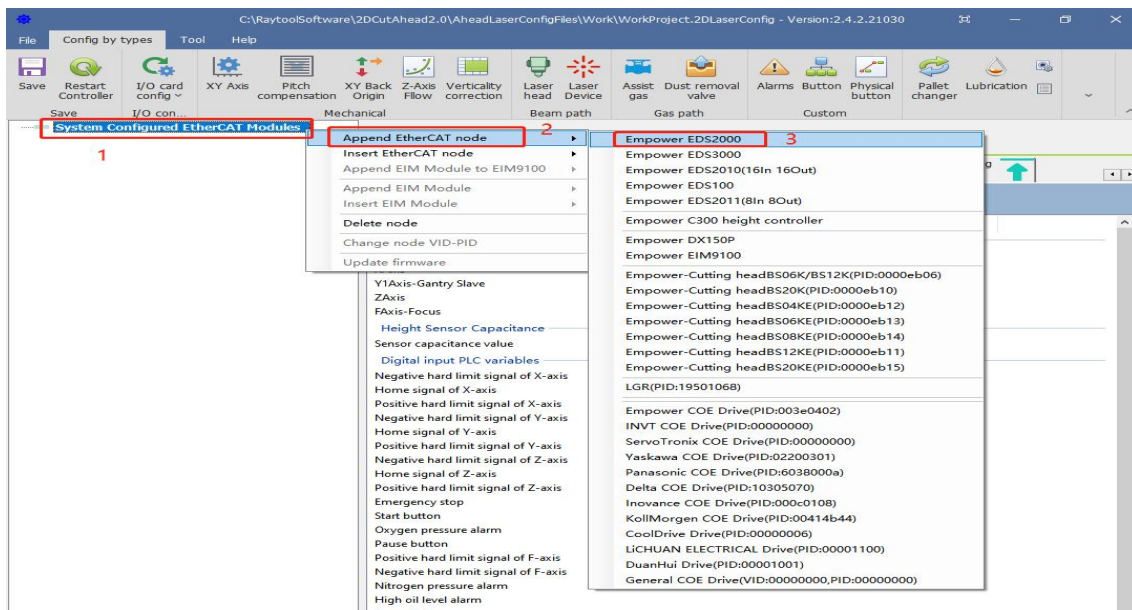

2) Appending completed

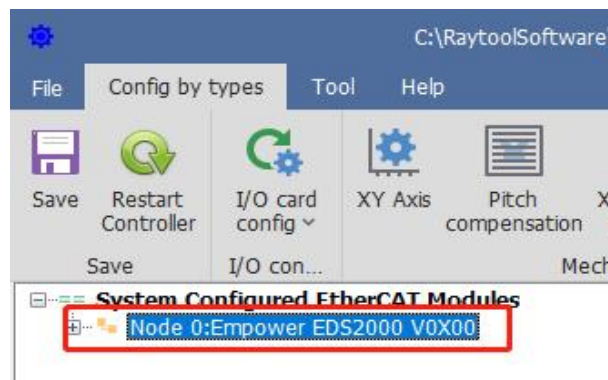

Insert

1) Select the insert location, right-click - Insert EtherCAT Node - select the slave to be inserted.

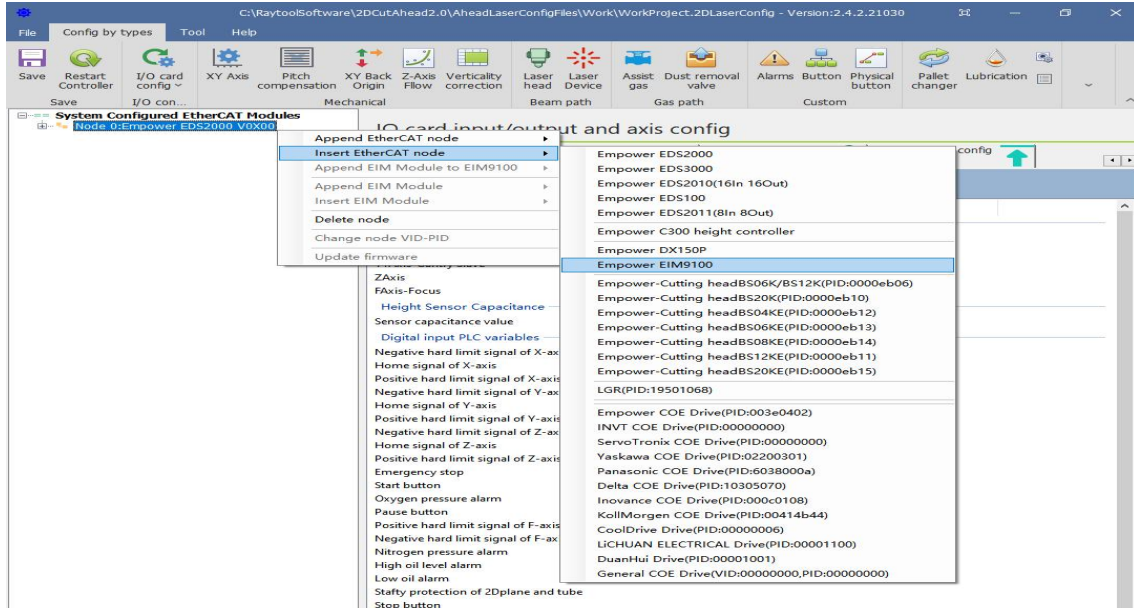

2) Insertion completed

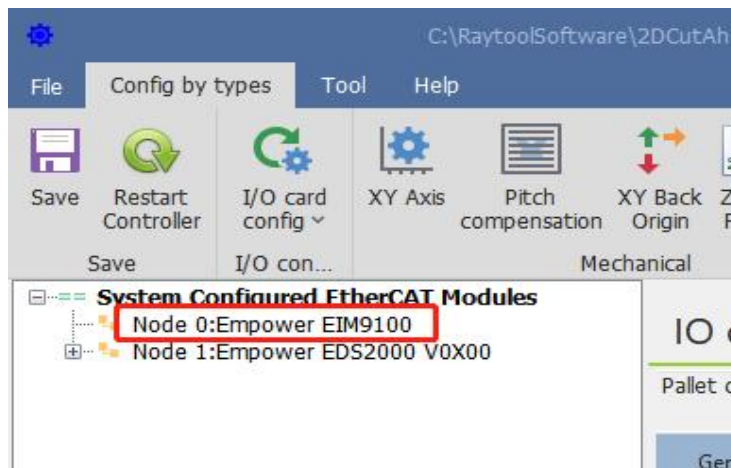

Delete

1) Select the slave that needs to be deleted, right-click - Delete node, and select Yes in the pop-up dialog box

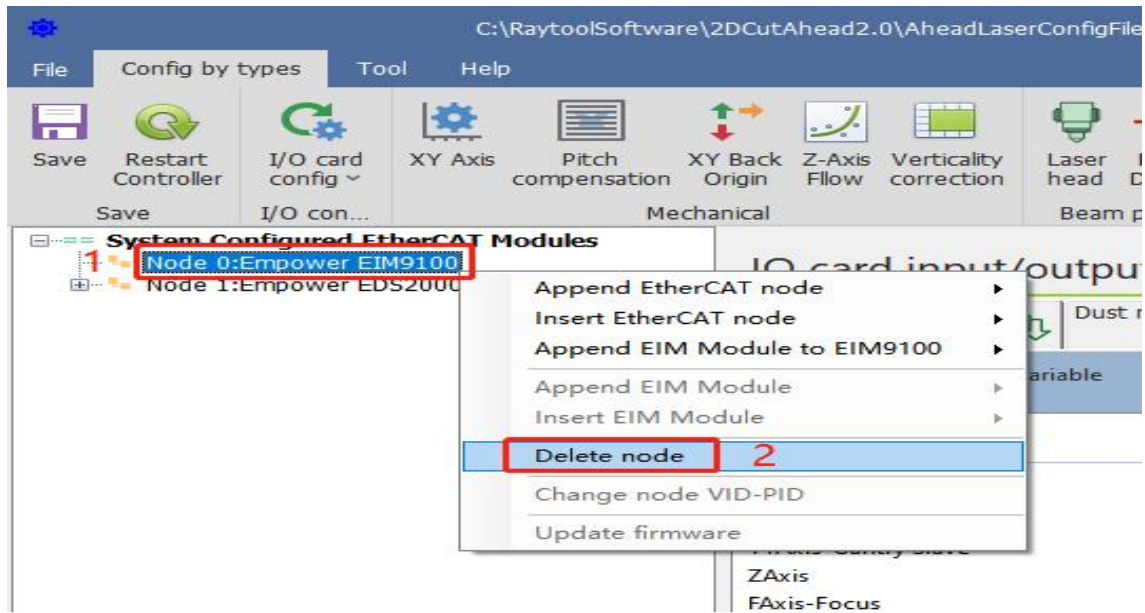

2) Delete completed

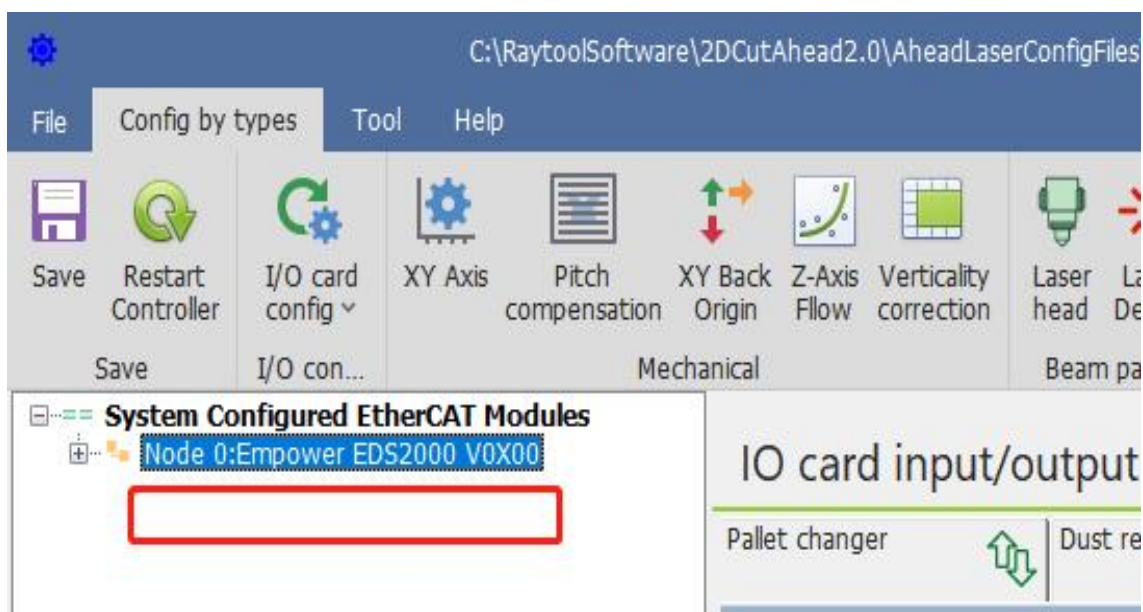

5.2.2 Changing the slave connection order

Method 1: Use the above add, insert, delete, and repeat operation to change the slave connection order.

Method 2: Select the slave station you need to move, press and hold the mouse and drag it to the location you want to move, and then release the left mouse button.

Note: The order from top to bottom is the actual order of the actual network cable serial slave, and the position must correspond one by one, otherwise the slave can't enter the OP state, resulting in the software can't operate!

5.2.3 Linking operations to slave sites

Add link:

- 1) Select the hardware pins to be linked and right click - Connection request.

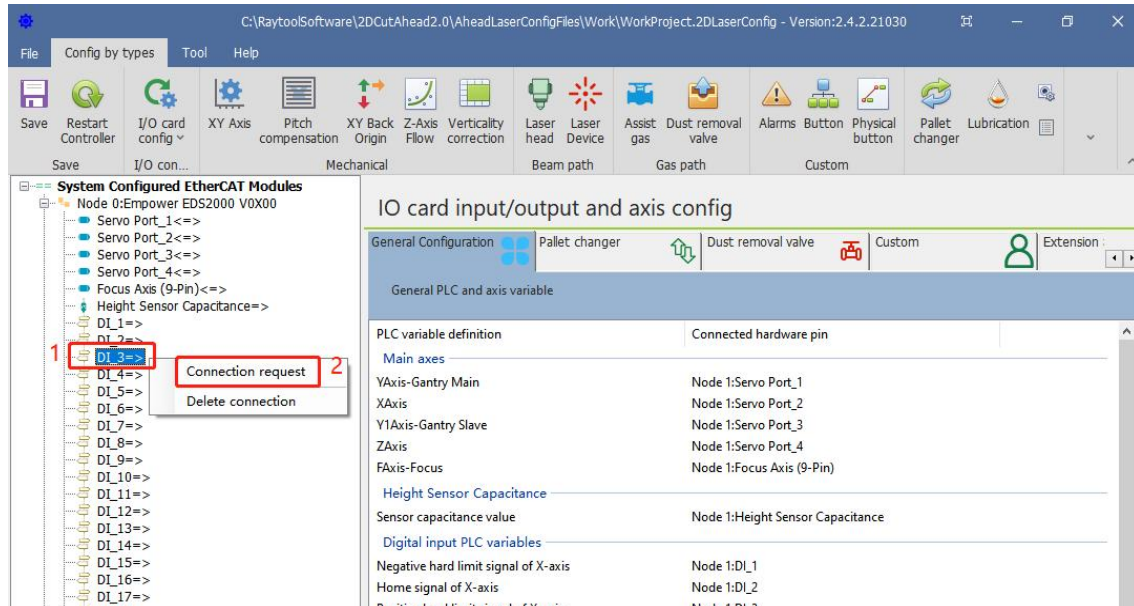

2) Select the PLC variable to be linked in the PLC variable area and right-click - Confirm connection.

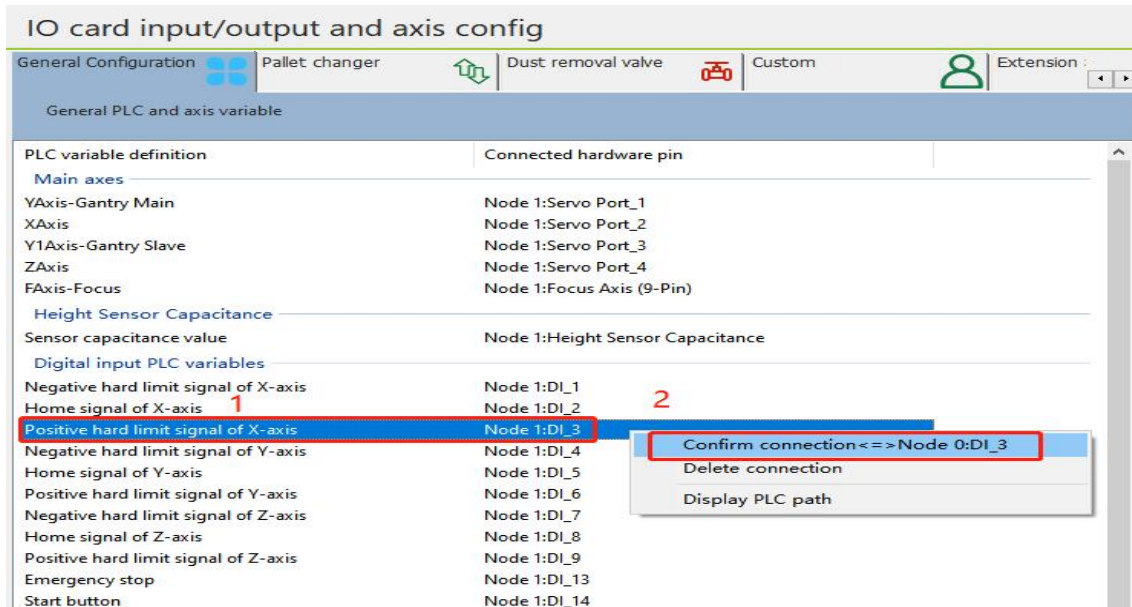

3) The link is complete and both the current configuration area and the PLC variable area have dotted link information.

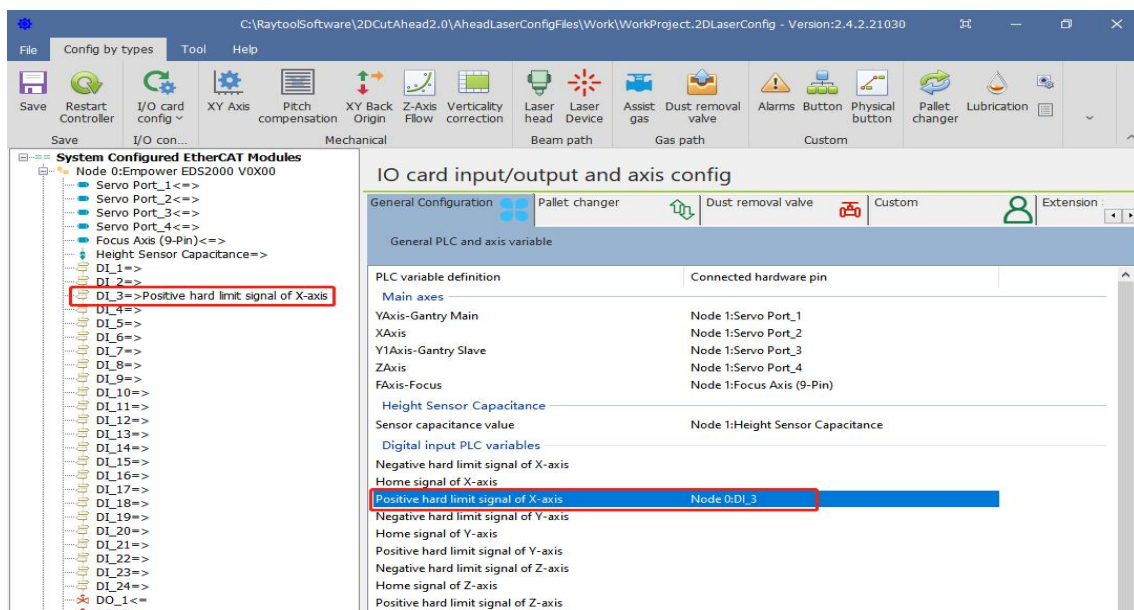

Delete the link:

Method 1:

1) Select the pin in the current configuration area where the link needs to be removed and right-click – Delete connection.

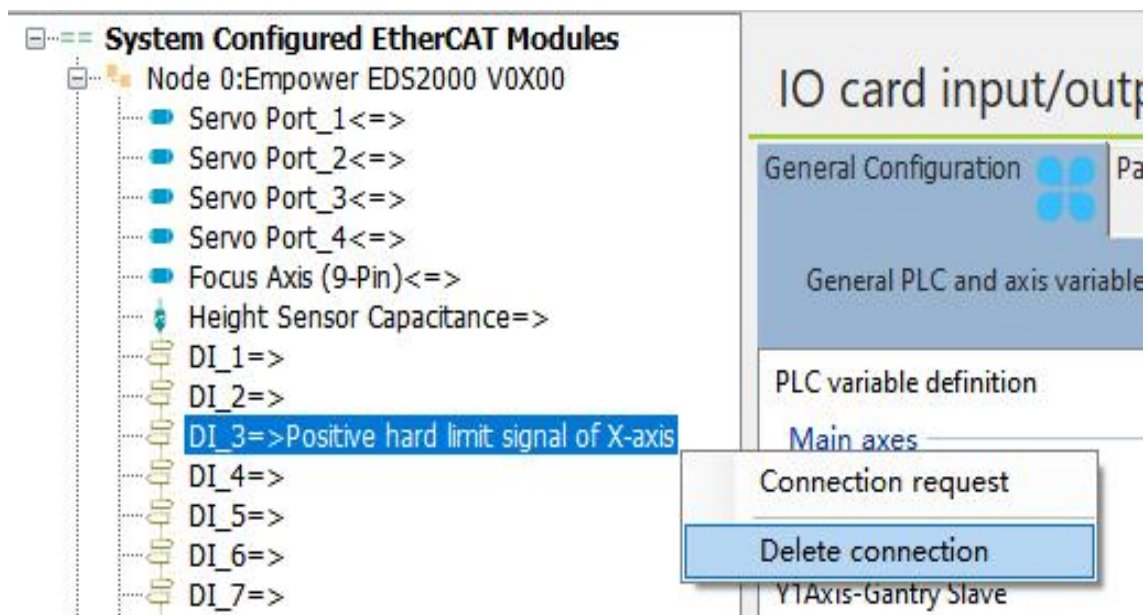

2) Delete completed

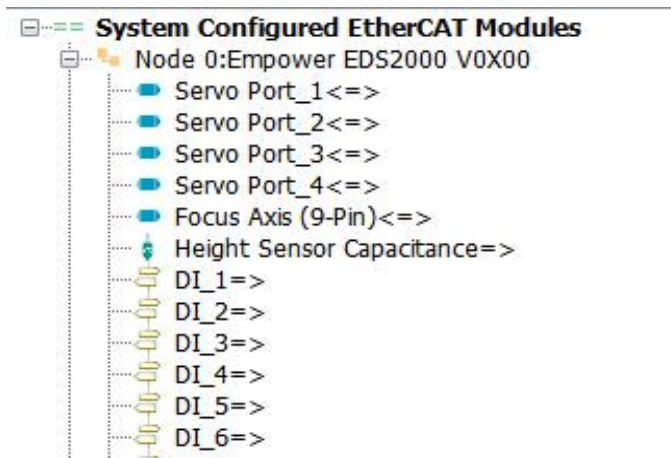

Method 2:

1) In the PLC Variables area, select the variable that needs to be deleted from the link and right-click - Delete connection.

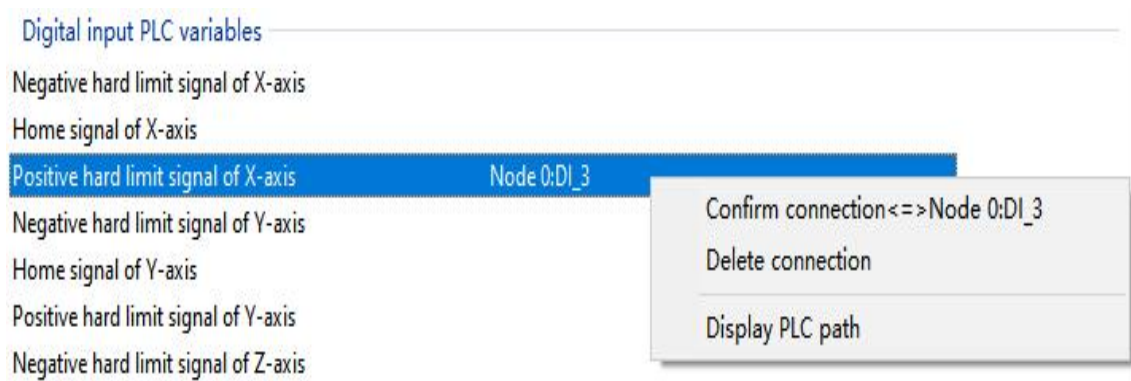

2) Delete completed

Change the link: first delete the original link, and then add the link again.

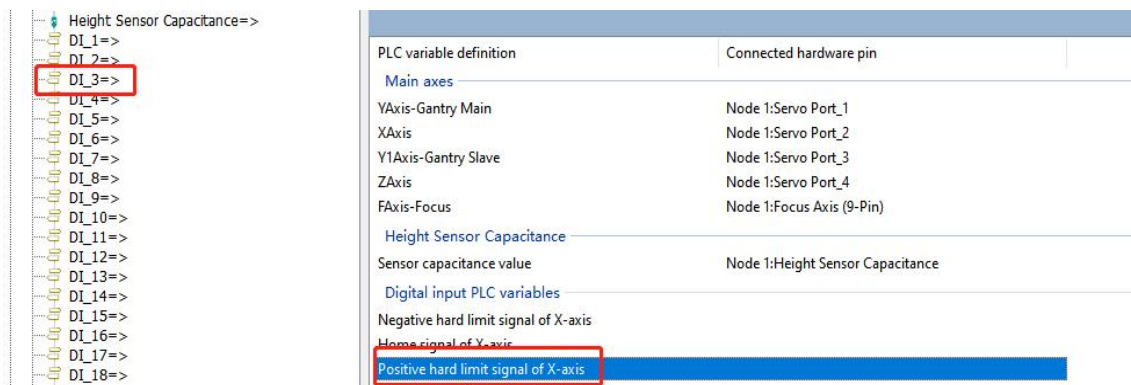

5.3 Example Demonstration

To familiarize customers with the overall usage process, this section will demonstrate two examples with the following requirements: Example 1:

Requirements: 1. Import XC3000 standard configuration, machine configuration as follows:
4 pulse servos for X, Y, Y1, Z axes, one EDS3000 board, use this configuration for the points in the standard configuration.

Process:

Open the configuration tool and enter the password: 4006701510.

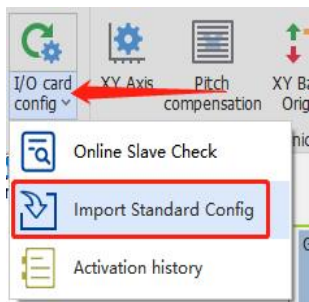

Click the Import Standard Config and then select XC3000S, EDS3000 Module, Pulse-dir servo in the pop-up box. After that check the unique file in the configuration and click Use selected config.

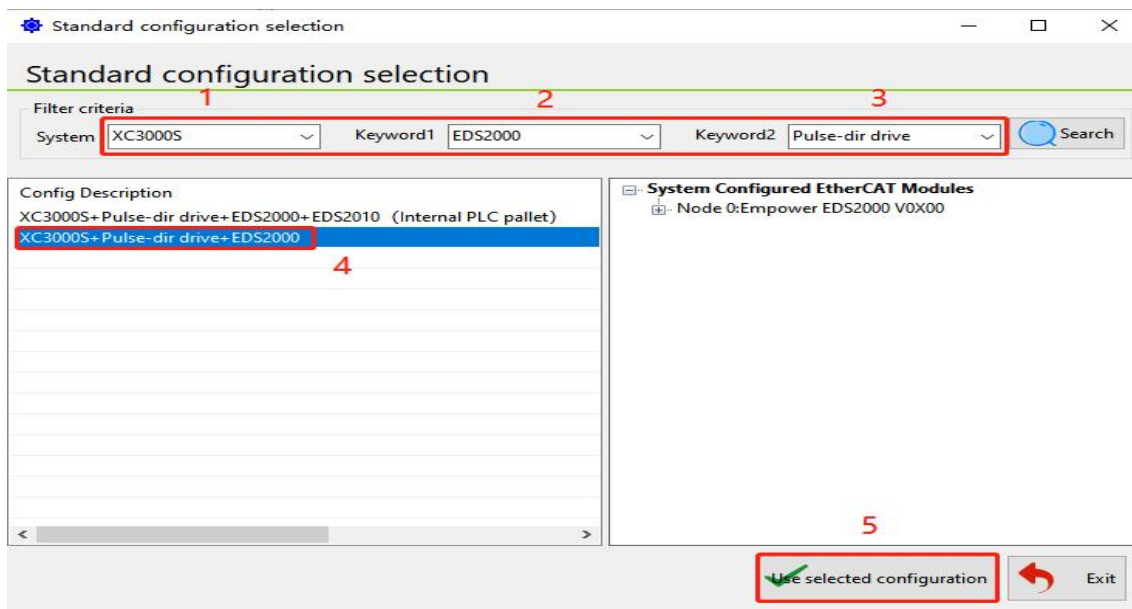

Click



then a dialog box will pop up, and just wait for the kernel to restart.

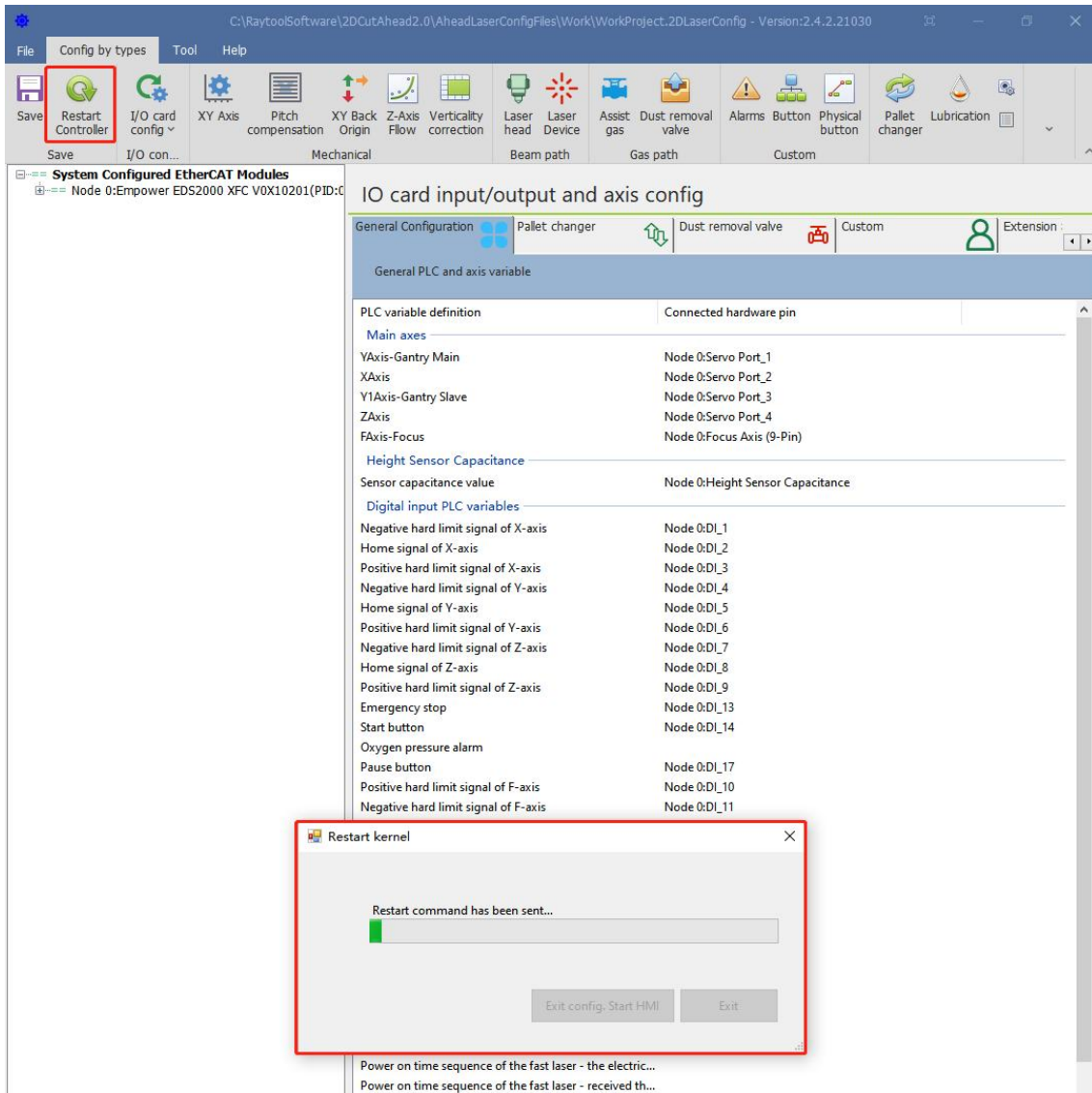

The screenshot shows the RAYTOOLS software interface. The main window is titled "System Configured EtherCAT Modules" and displays "IO card input/output and axis config". The toolbar at the top contains various icons, with the "Restart Controller" icon (a green circular arrow) highlighted with a red box. A dialog box titled "Restart kernel" is overlaid on the main window, showing a progress bar and the text "Restart command has been sent...". The dialog box has two buttons: "Exit config_Start HMI" and "Exit".

PLC variable definition	Connected hardware pin
Main axes	
YAxis-Gantry Main	Node 0:Servo Port_1
XAxis	Node 0:Servo Port_2
Y1Axis-Gantry Slave	Node 0:Servo Port_3
ZAxis	Node 0:Servo Port_4
FAxis-Focus	Node 0:Focus Axis (9-Pin)
Height Sensor Capacitance	
Sensor capacitance value	Node 0:Height Sensor Capacitance
Digital input PLC variables	
Negative hard limit signal of X-axis	Node 0:DI_1
Home signal of X-axis	Node 0:DI_2
Positive hard limit signal of X-axis	Node 0:DI_3
Negative hard limit signal of Y-axis	Node 0:DI_4
Home signal of Y-axis	Node 0:DI_5
Positive hard limit signal of Y-axis	Node 0:DI_6
Negative hard limit signal of Z-axis	Node 0:DI_7
Home signal of Z-axis	Node 0:DI_8
Positive hard limit signal of Z-axis	Node 0:DI_9
Emergency stop	Node 0:DI_13
Start button	Node 0:DI_14
Oxygen pressure alarm	
Pause button	Node 0:DI_17
Positive hard limit signal of F-axis	Node 0:DI_10
Negative hard limit signal of F-axis	Node 0:DI_11

Example 2:

Requirements:

1、 The existing machine configuration is as follows:

Panasonic servo motors 4, respectively for X, Y, Y1, Z axis, an EDS board, you need to connect all the limit signals according to the standard points, the network cable connection order is Y, X, Y1, Z, EDS3000 board, delete the nodes in the current configuration area and create a new configuration, backup the new configuration in order to import to other replicators with the same configuration.

Process:

1) Open the configuration tool and input the password: 4006701510 to delete the previous configuration node through the operation in subsection 4.2.1.

Add 4 Panasonic Servos and one EDS3000 board to the blank configuration and adjust the position according to the actual network cable connection order.

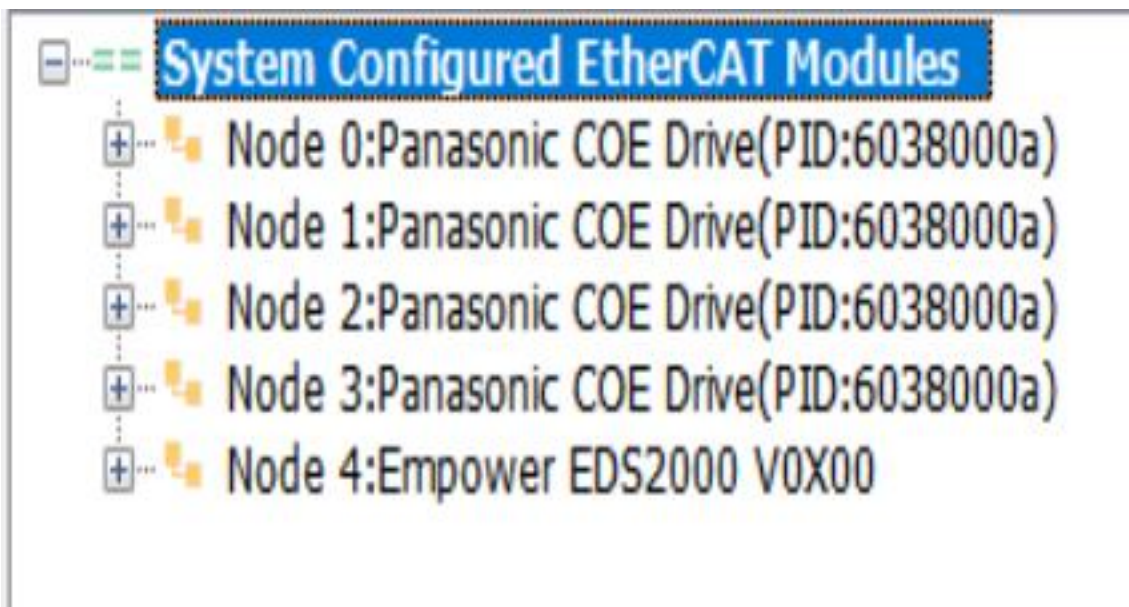

2) Turn on the first servo (station 0) and connect it to the Y-axis; turn on the second servo (station 1) and connect it to the X-axis; turn on the third servo (station 2) and connect it to the Y1-axis; turn on the fourth servo (station 3) and connect it to the Z-axis.

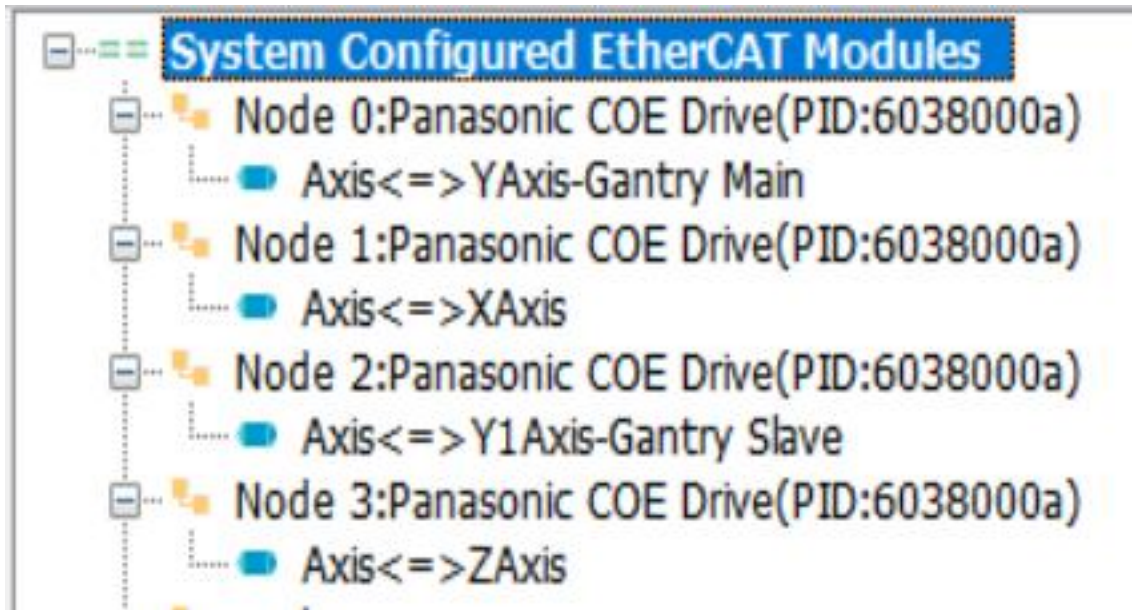

3) Tap on the EDS3000 and connect all limit signals according to the actual wiring.

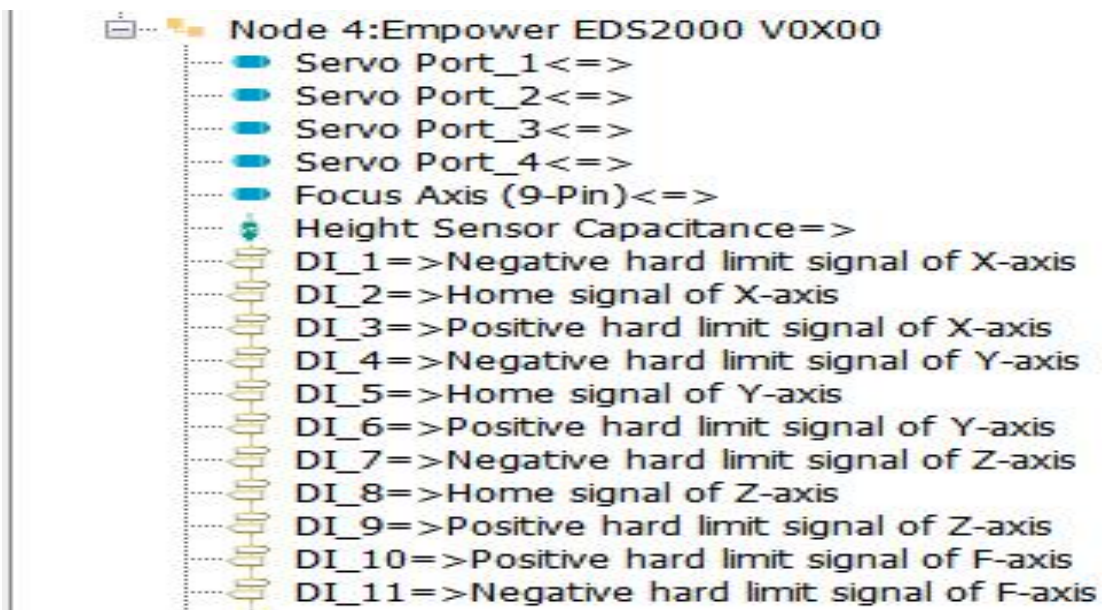



System Commissioning Manual

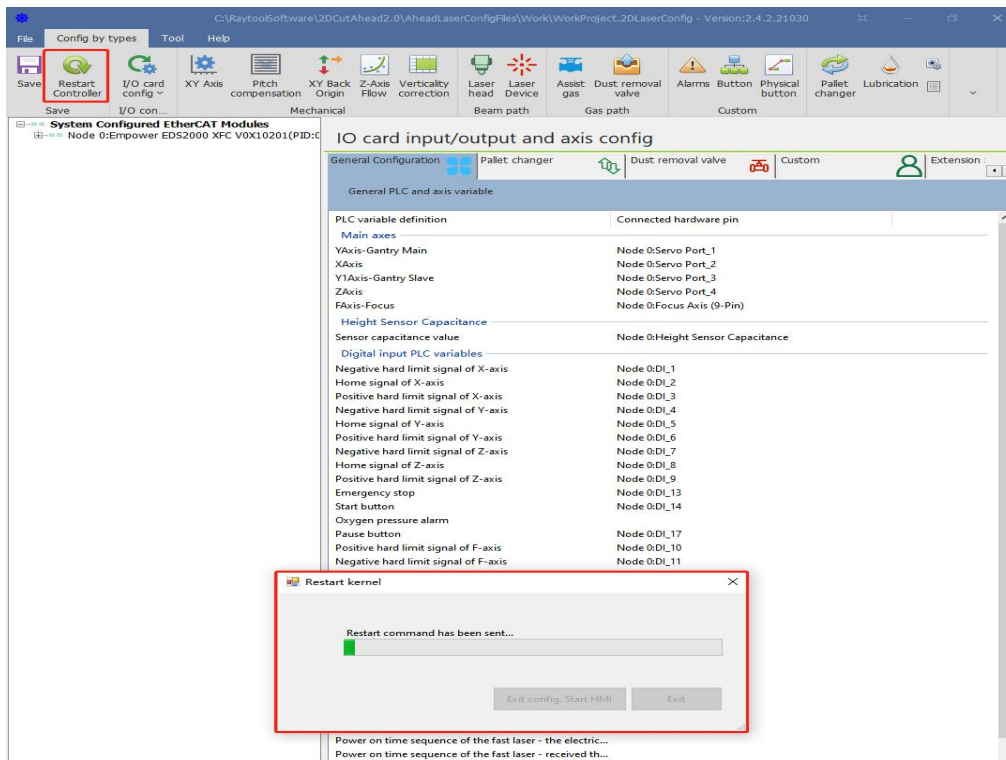

Confirm the configuration and click Save, then click  in Tool under the sub-page to back up the current configuration. Subsequent copies of the model can be imported directly into this backup file.

Click  and click OK on the pop-up dialog, and wait for the kernel to restart.



For another machine with the same configuration, you can directly click  to open the previously saved backup file, to quickly copy the machine configuration and speed up the installation and commissioning efficiency.

6 Precautions and exception handling

6.1 Electrical and commissioning considerations

6.1.1 Solenoid valve must be connected in parallel with a continuity diode

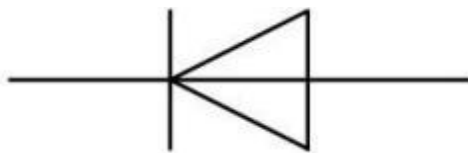

The diode has a unidirectional conductivity, that is, the diode anode and cathode with a positive voltage, the diode conducts. When the reverse voltage is added to the anode and cathode, the diode is cut off. Diode conduction and cut-off, then the equivalent of the switch on and off. Our diodes are equipped with MIC 6A10.

The following is a wiring diagram and a physical drawing

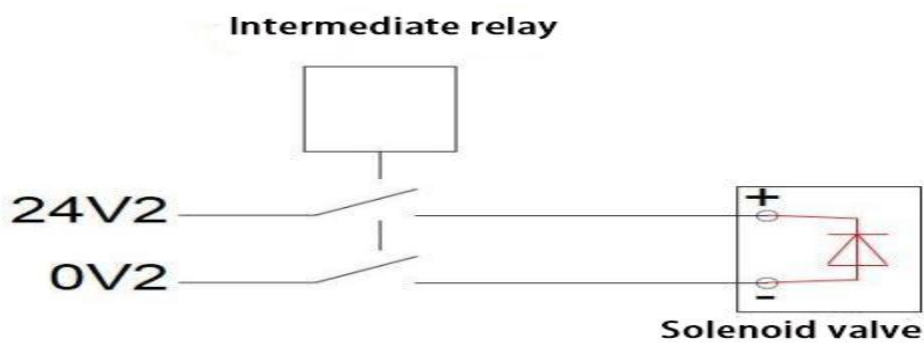

Note: When connecting the diode, you need to pay attention to the cathode and anode of the diode,

DC power 24V to the cathode of the diode, DC power 0V to the anode of the diode; Connection in reverse will lead to a short circuit.

6.1.2 Power supply wiring specification

- 1、 The power supply requires electrical installation specifications and separation of low and high voltage.
- 2、 24 power supply and payload with the relatively large interference (such as servo, solenoid valve) and the controller should take power supply separately.

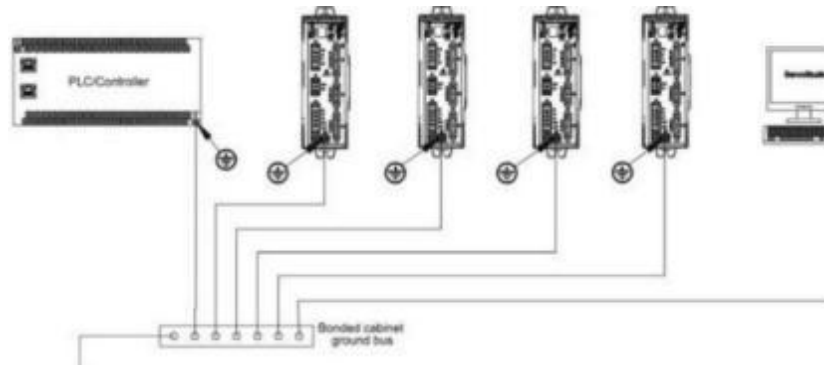

- 3、 Servo grounding recommended to use star connection, as the correct connection can ensure the stable operation of the equipment.

6.2 F-axis abnormality handling method

If F-axis control is abnormal without alarm when using axis control mode to control F-axis, please follow the steps below to troubleshoot.

6.2.1 Control BM109 Cutting head abnormal treatment

If the servo does not have any alarm but the software has an F-axis drive alarm, change the drive parameter PR16 to 1 and save it according to the following procedure.

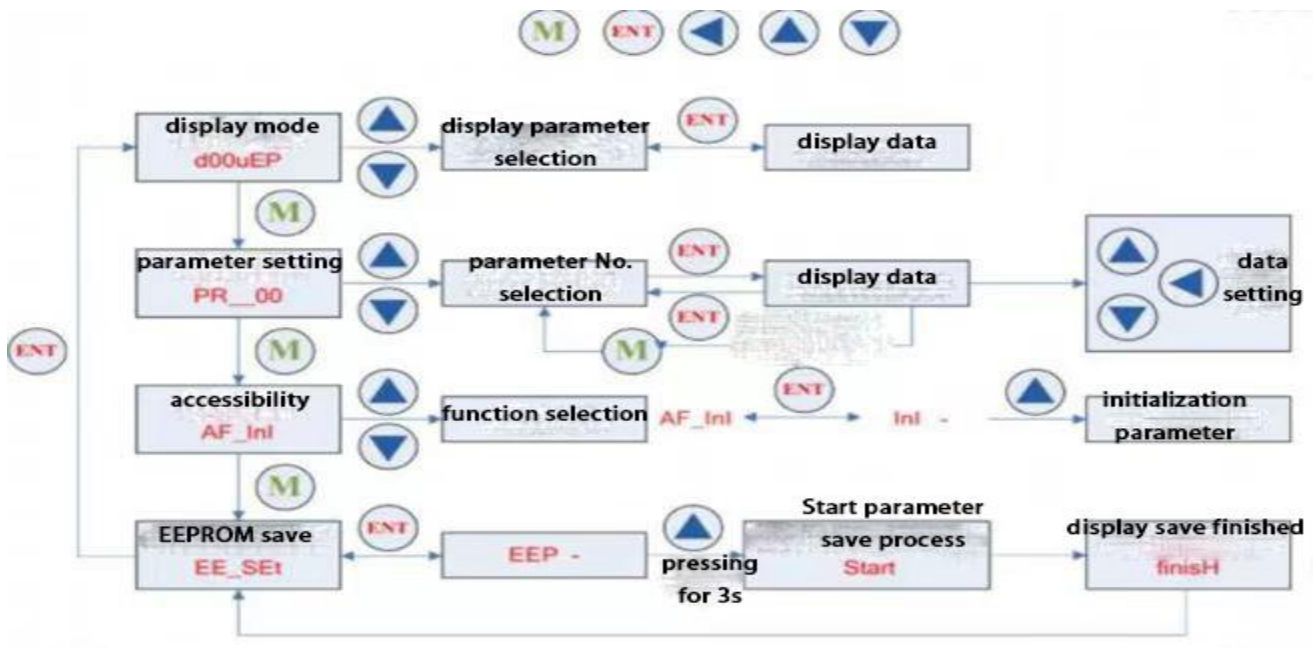

6.2.2 BM111 Yaskawa Focusing Driver

If the drive can be enabled, but cannot control the motor movement, please change the drive parameter Pn000 to 0011.

6.3 Normal Questions

6.3.1 Host cannot enter the system

1. Confirm that the host and monitor 220V power supply is normal, and use the universal measurement host input power. The standard host power supply is DC12V.
2. Reboot the host to observe if it can enter the host interface normally.
3. Program run-down for abnormal system problems. The system is equipped with a one-key restore system function: one-key (OneKEY) to restore in the boot page.

6.3.2 Enter the system sheet showing that the slave is not connected or not in OP status

1. Check whether the network cable order is connected as required, and the connection order please refer to (1.2 System Composition and Connection Order).
2. Check the network cable and the board for bad contact.

6.3.3 Software interface to view slave communication status

If you encounter communication interruptions, check the following steps: Find the "Hardware" button on the left side of the main screen, and click on it to refer to the communication problems.

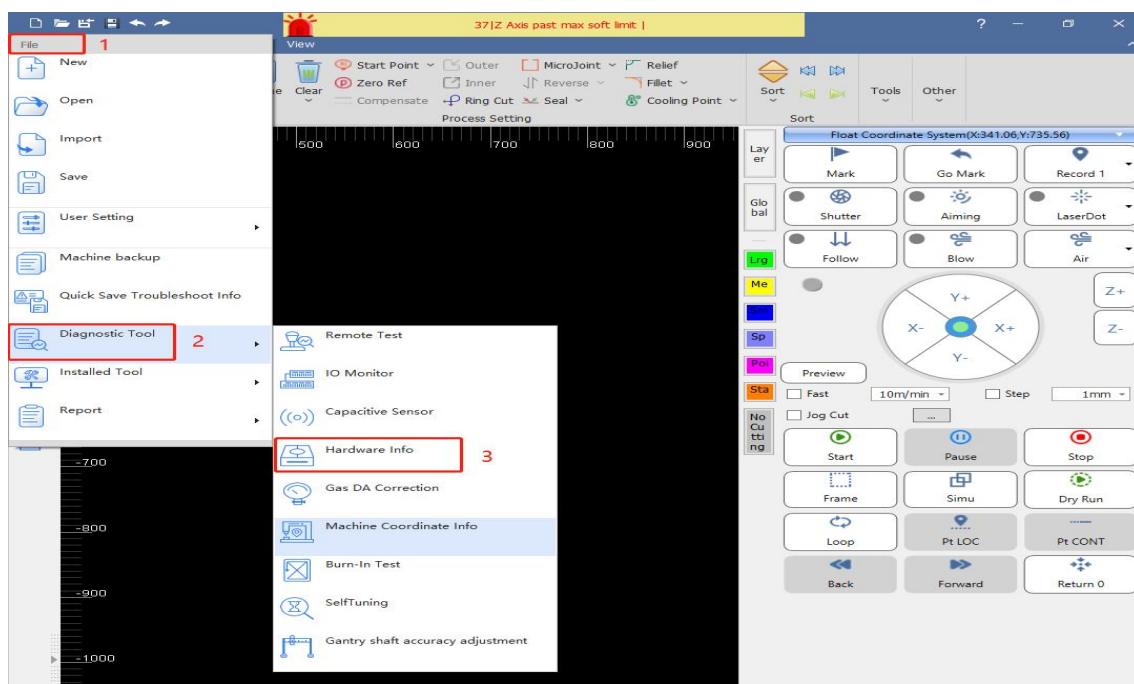

The screenshot shows a software window titled "FormHardWare" with a close button (X) in the top right corner. The window contains a table with the following data:

Slave station order	Slave station name	Op Status	P0-Crc	P0-PHY	P1-Crc	P1-PHY	P2-Crc	P2-PHY
0	HCFA	OP	0	0	0	0		
1	HCFA	OP	0	0	0	0		
2	HCFA	OP	0	0	0	0		
3	HCFA	OP	0	0	0	0		
4	EDS3000	OP	0	140				

Below the table, the following system information is displayed:

Master0
Phase: Operation
Active: yes
Slaves: 5
Ethernet devices:
Main: 00:e2:69:2a:47:76 (attached)
Link: UP
Tx frames: 15650978
Tx bytes: 5451699690
Rx frames: 15650977

At the bottom of the window, there are two buttons: "Reset Salve Register" and "Exit".

If the OP status column doesn't show OP, the communication is not connected; if PO-Crc or P0-PHY has a non-zero value in any column, it means the slave is interfered with, and if the value is large, it means the communication is broken. You need to find the appropriate slave to observe if it is a wiring alignment problem, or a hardware or network cable problem.

Note: All network cables, encoder cables and sensor cables on the amplifier should not be tied together with the power cable.

If the servo is connected to the servo through the network cable, and the communication interruption between the servo is detected, check whether the network cable between the servo and the servo is well connected, and whether the connection between the crystal head of the network cable and the servo is well connected and loose.

Wiring Precautions:

- (1.) Confirm that the site of the electrical control cabinet is well grounded. Resistance within 10 ohms, the smaller the better (preferably can be installed independent ground stake, only for laser cutting machine)
- (2.) Low voltage and high voltage cables need to be separated. Don't entangle each other Network cable connection display indication

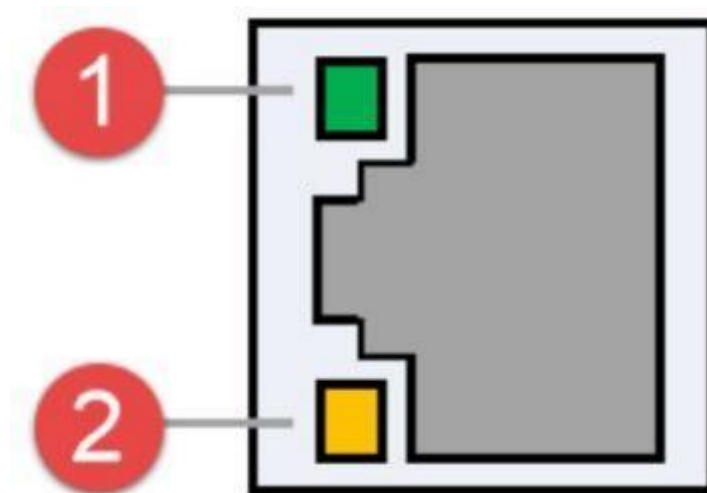

EtherCAT Interface / Ethernet Interface

EtherCAT Interface Connection Status					
Description					
EtherCAT	Tags	Description	LED Color	Status	Description
	1: Speed	EtherCAT bus connection speed	Green	Extinguished	10 Mbps connection
				Always bright	100 Mbps connection
			Orange	Always bright	1000 Mbps connection
	2: LINK	EtherCAT Bus Link Status	Yellow	Extinguished	No connection
				Blinking	In data communication
				Always bright	Connected

Ethernet interface connection status description					
	Tags	Description	LED Color	Status	Description
Ethernet	1: Speed	Ethernet communication connection speed	Green	Extinguished	10 Mbps connection
				Always bright	100 Mbps connection
			Orange	Always bright	1000 Mbps connection
	2: LINK	Ethernet Communication link status	Yellow	Extinguished	No connection
				Blinking	In data communication
				Always bright	Connected

7 Appendix

7.1 EDS2000 (Optional)

The XC3000S is compatible with the EDS2000 board. EDS2000 is available when EDS3000 is not used.

7.1.1 EDS2000 IO Card

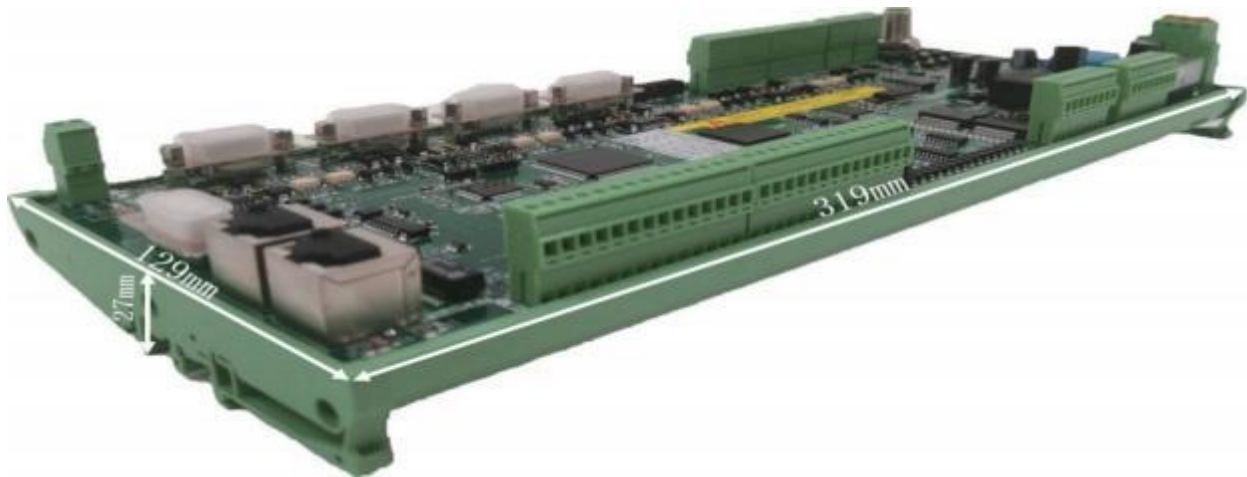

The EDS2000 is an EtherCAT bus-based slave interface board with a rich set of IO, motion control and laser follower interfaces and resources, especially for signal acquisition and motion control applications in the laser industry.

7.1.2 EDS2000 Wiring Diagram

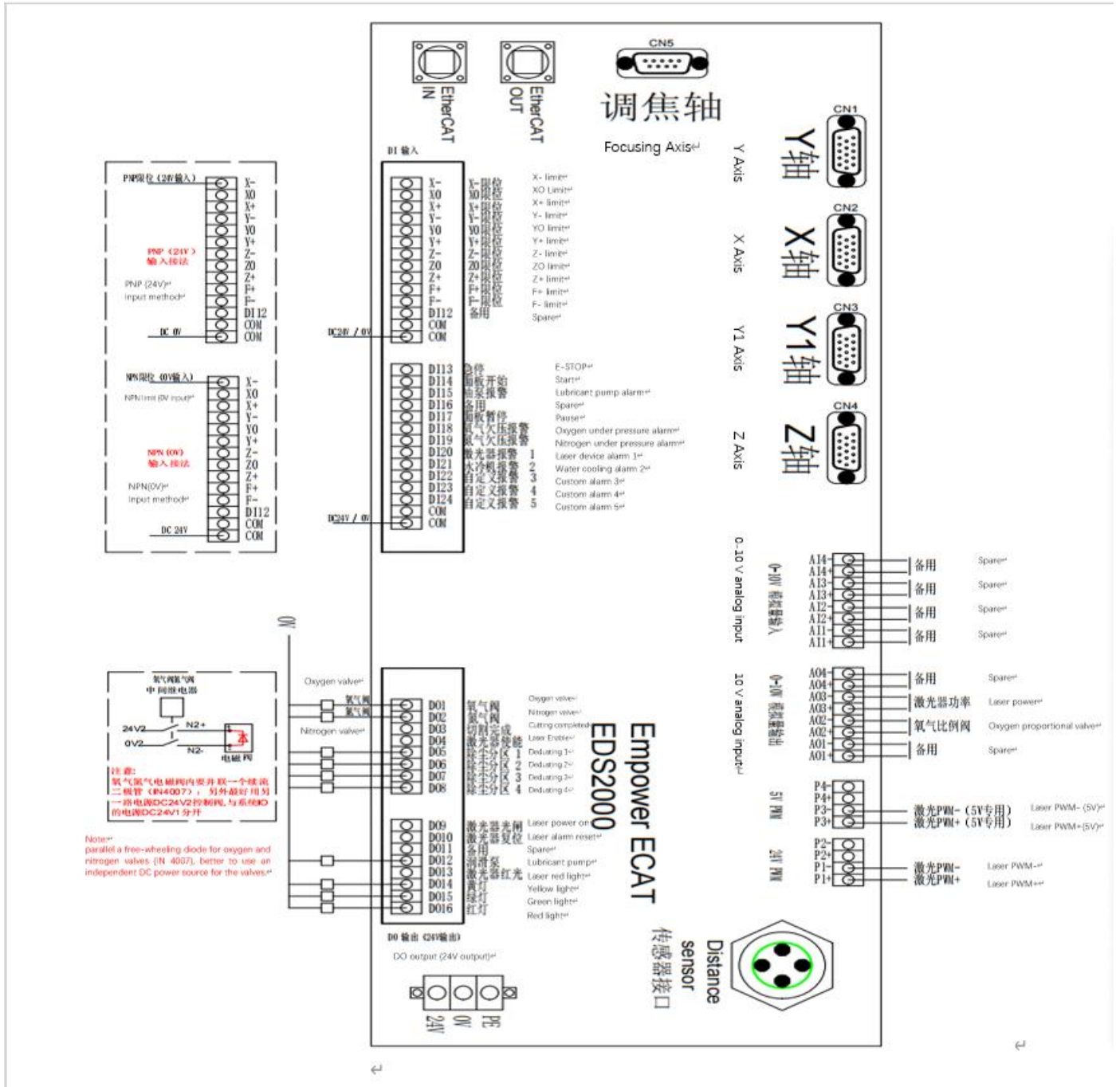

7.1.3 EDS2000 Laser Point Diagram

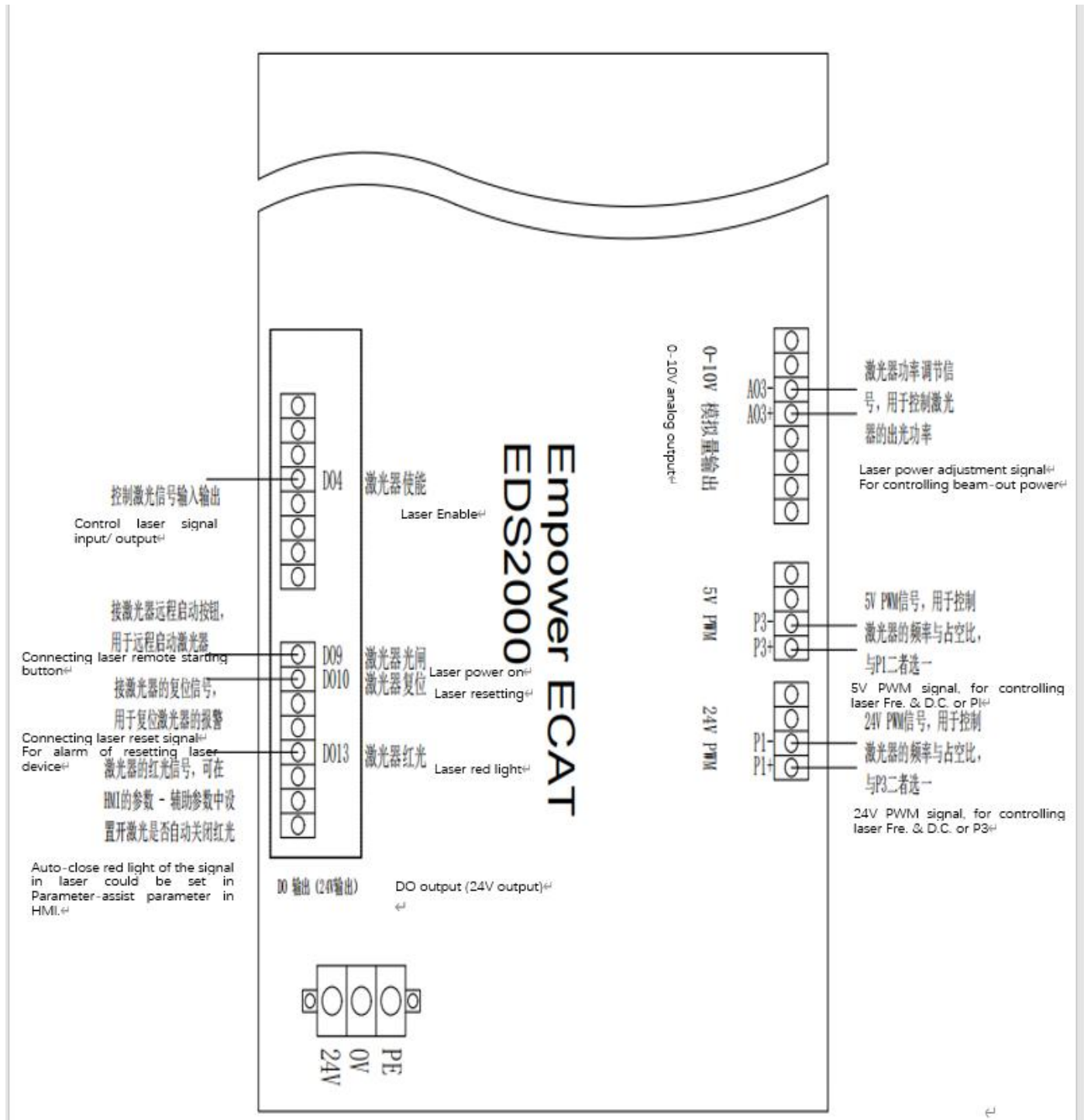

7.1.4 EDS2000 Servo Drive Interface

1) The four servo control interfaces on the general-purpose axis (X,Y, Y1, Z) interface board are three-row DB15 (hole) sockets, as shown in the figure below

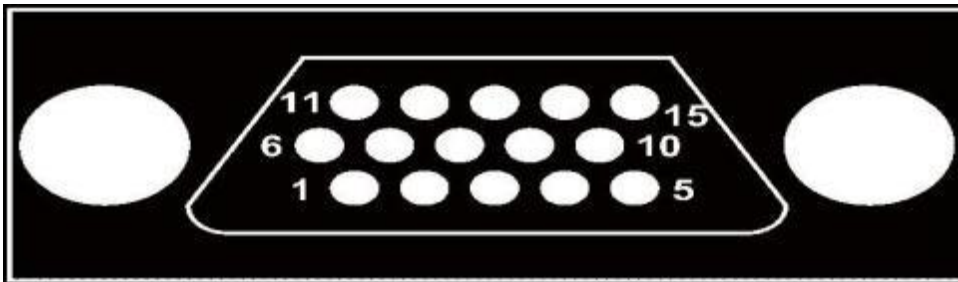

The pins are defined as follows:

Foot number	Signal Name	Function	Foot number	Signal Name	Function
1	A+	A-phase encoder pulse input +	13	XD+	Axis rotation direction switching output +
2	A-	A-phase encoder pulse input -	14	XD-	Axis rotation direction switching output -
3	B+	B-phase encoder pulse input +	8	ALM	Servo alarm input
4	B-	B-phase encoder pulse input -	9	SON	Servo enable output
5	Z+	Z-phase encoder pulse input +	10	CLR	Axis Clear Output
7	Z-	Z-phase encoder pulse input -	6	P24V	24V power supply
11	XP+	Axis speed control output +	15	PGND	Power Ground
12	XP-	Axis speed control			

		output -			
--	--	----------	--	--	--

2) The 1 F-axis control connector on the focus axis (F-axis) interface board is a two-row DB9 (hole) socket, as shown in the following figure:

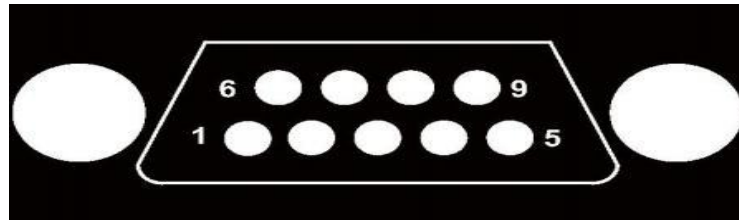

The pins are defined as follows:

F-axis interface signal description					
Foot number	Signal Name	Function	Foot number	Signal Name	Function
1	CLR	Axis Clear Output	6	SON	Axis rotation direction switching output +
2	ALM	Servo alarm input	7	PP	Axis rotation direction switching output -
3	NP	Axis speed control output -	8	ND	Servo alarm input
4	PD	Axis rotation direction switching output +	9	PGND	Servo enable output
5	P24V	24V power supply			

Note: EDS2000 board SON and ALM signals are active low (0V output active and 0V input active).

3) Servo driver control signal wiring diagram.

The following items should be noted when connecting the servo drive:

The EDS2000 uses a pulse + direction signal to control the servo drive, and you must confirm that the drive supports this mode.

Confirm the selected type of Servo Drive Enable Signal (SON) is active low (ON when conducting with 24V power ground).

Confirm the selected type of Servo Drive alarm signal (ALM) is active low (ON when conducting with 24V power ground).

Confirm the servo drive parameters are set correctly. If the servo cannot run, the parameters should be set to "Forward and reverse input disable". The F-axis servo interface is an open-loop control interface and does not support encoder signal input.

Wiring with Yaskawa, HCFA, Panasonic, Delta B series & A2 series, and Fuji servo drives, please refer to the following wiring diagram.

If you have any questions, please consult our technical professionals.

7.1.5 EDS2000 Servo Drive Interface

Yaskawa E-7 Series AC Servo Drive Wiring Diagram

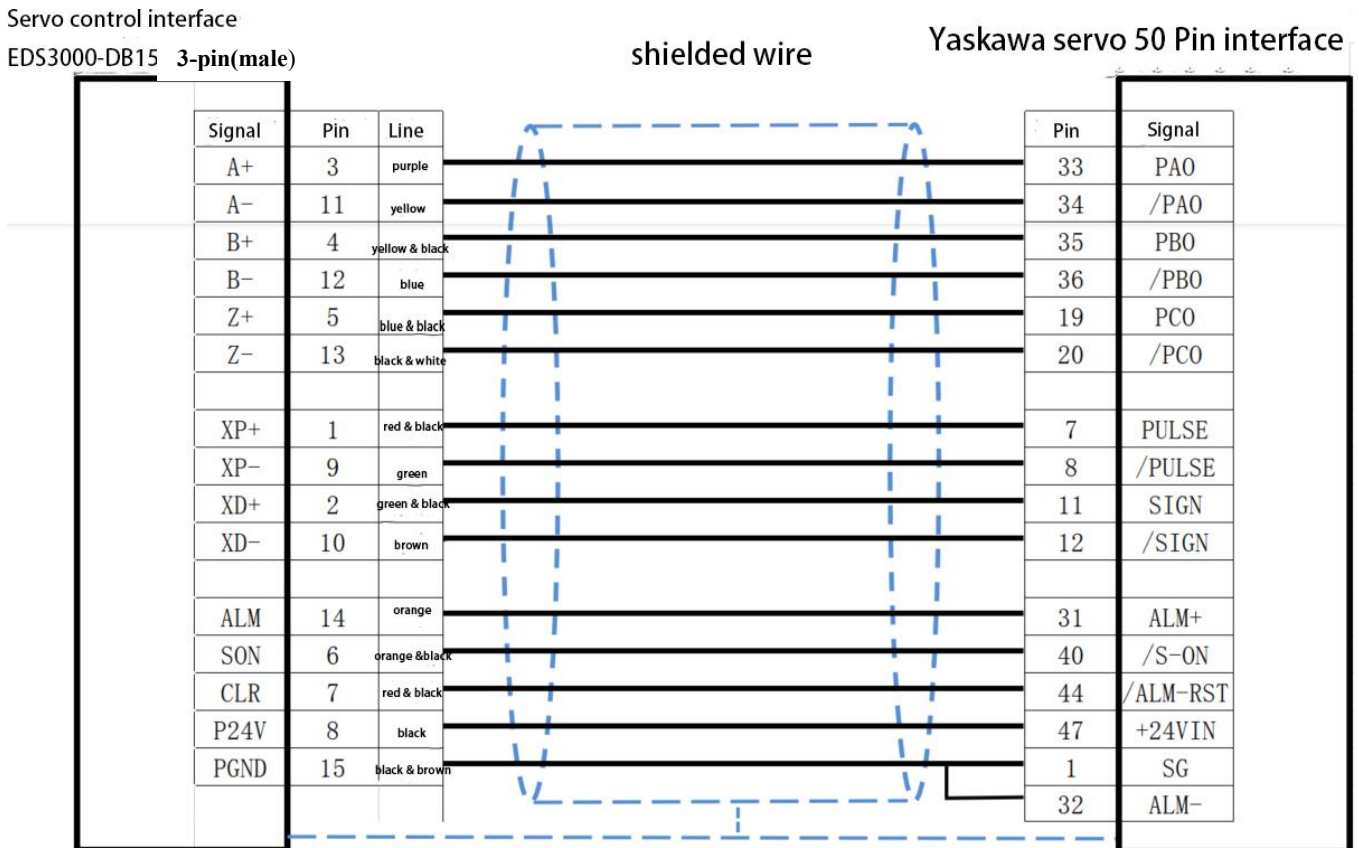

Yaskawa Servo Setting Parameters

Parameter Type	Recommended Value	Setting range
Pn000	0.0.1.0	0.0.x.0 (0 speed; 1 position) 0.0.0.X (0 forward; 1 reverse)
Pn000	0.1.0.1	0.X.0.0 (0 three-phase power; 1 single-phase power); 0.0.0.X (0 display setting, 1 display all parameters)

Pn200	0.0.0.0	0.0.0.X (0 pulses + direction positive logic, 5 pulses + direction negative logic). X.0.0.0 (linear 1M)
Pn50A	8100	Positive turn prohibition cancellation
Pn50B	6548	Reverse ban cancellation

HCFA Servo Drive Wiring Diagram

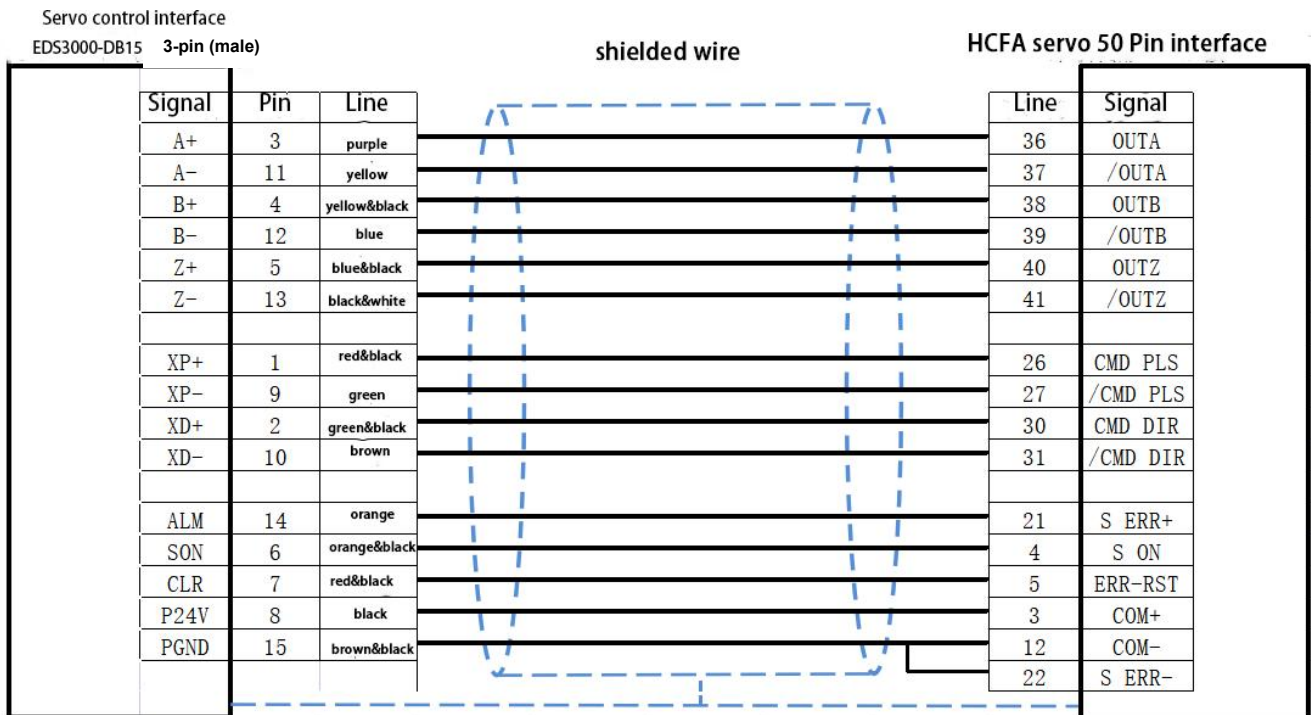

HCFA Servo Setting Parameters		
Parameter Type	Recommended Value	Setting range
P00-01	0	0 Position mode; 1 Speed mode; 7 Bus mode
P00-07	0	0: Pulse + direction positive logic; 1 Pulse - direction negative logic
P00-16	1	0: forward; 1: reverse

Panasonic MINAS A6 AC Servo Drive

Wiring Diagram

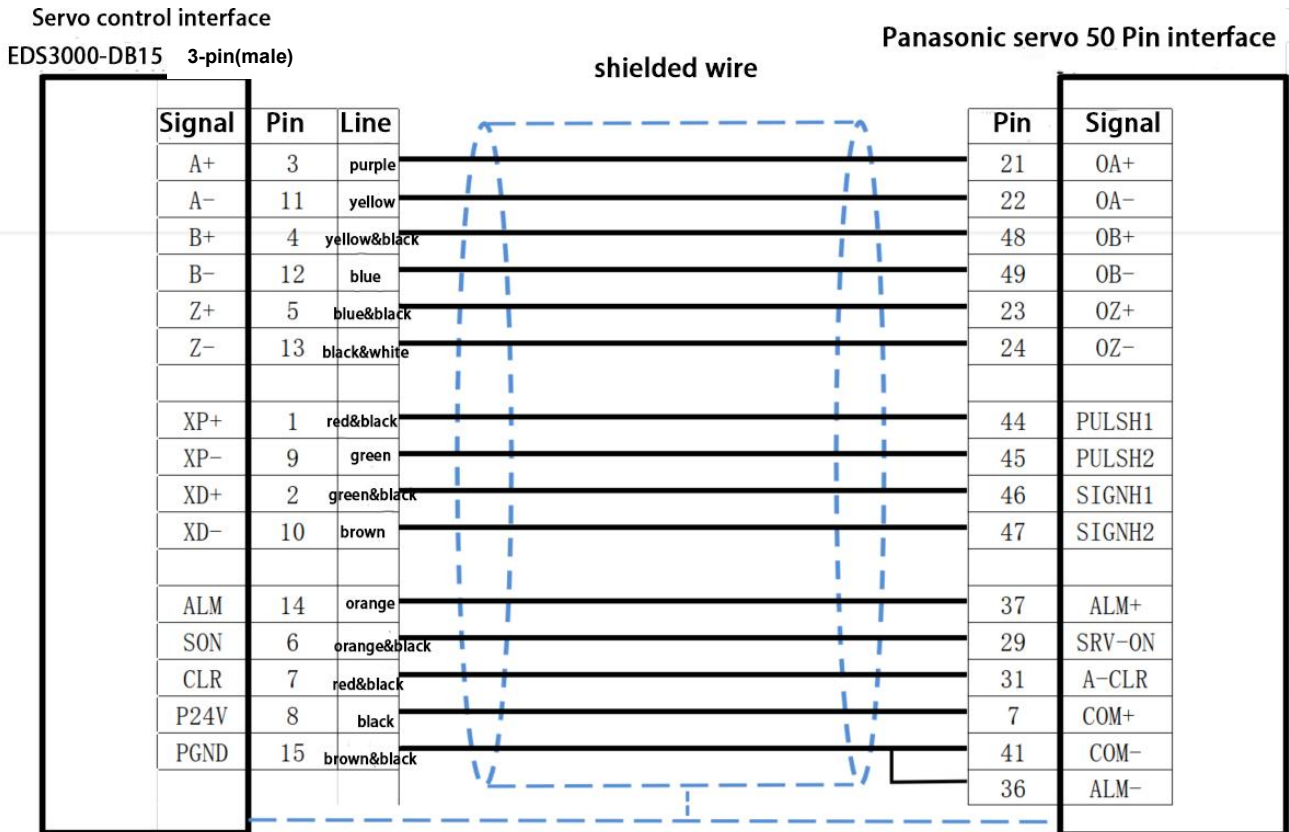

Panasonic Servo Setting Parameters

Parameter Type	Recommended Value	Setting range
Pr001	0	0: Position control, 1: Speed control
Pr007	3	3: Pulse plus direction
Pr005	1	1: High-speed pulse 3mpa;0: Low-speed pulse 500kpps

Delta B Series Servo Drive

Wiring Diagram

Servo control interface

EDS3000-DB15 3-pin (male)

Signal	Pin	Line
A+	3	purple
A-	11	yellow
B+	4	yellow&black
B-	12	blue
Z+	5	blue&black
Z-	13	black&white
XP+	1	red&black
XP-	9	green
XD+	2	green&black
XD-	10	brown
ALM	14	orange
SON	6	orange&black
CLR	7	red&black
P24V	8	black
PGND	15	brown&black

shielded wire

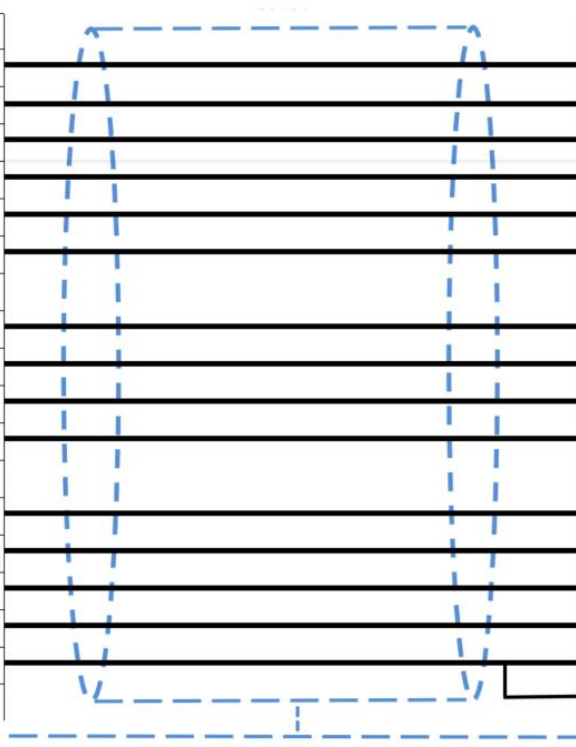

Delta servo 44 Pin interface

Pin	Signal
21	0A
22	/0A
25	0B
23	/0B
13	0Z
24	/0Z
38	HPULSE
36	/HPULSE
42	HSIGN
40	/HSIGN
28	ALRM+
9	SON
33	ARST
11	COM+
14	COM-
27	ALRM-

Servo control interface

EDS3000-DB15 3-pin(male)

shielded wire

Delta servo 50 Pin interface

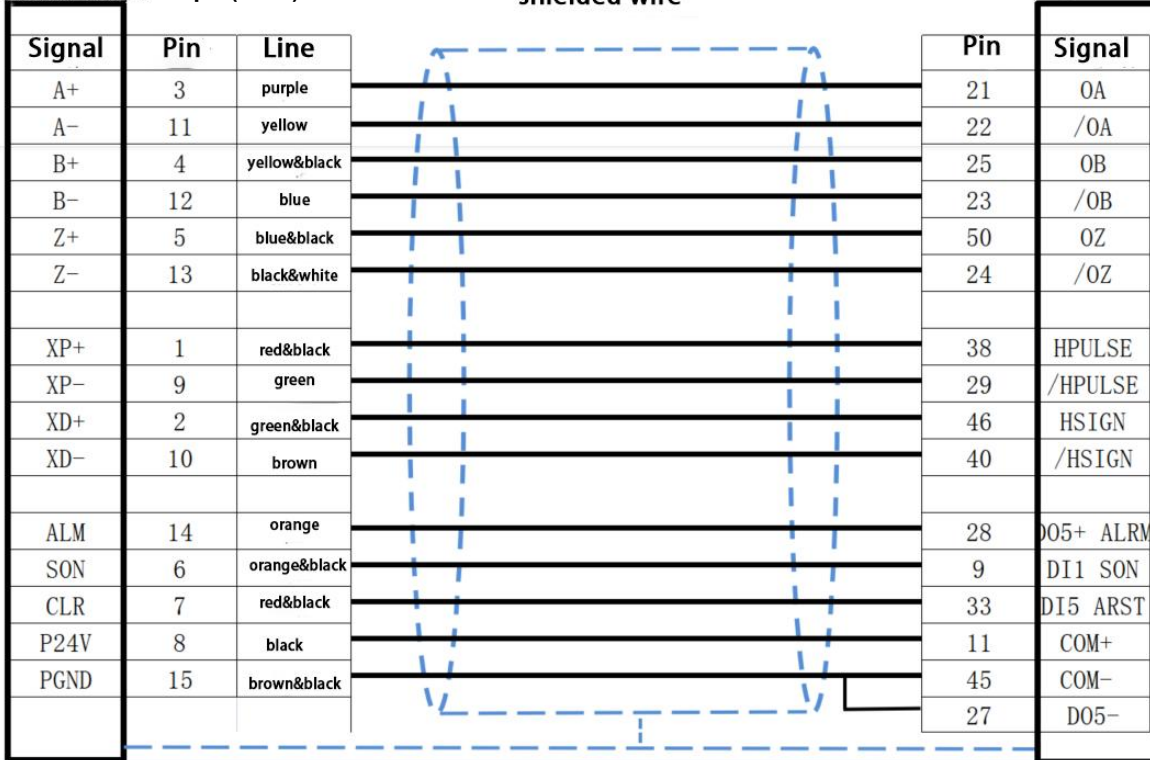

Delta Servo Setting Parameters		
Parameter Type	Recommended Value	Setting range
P1-00	0x1002	Thousands of bits 1 High-speed differential
P1-01	0x0000	Percentile 1 is the reverse
P2-10	0x0101	DI1

Fuji ALPHA5 Smart Servo Drive Wiring Diagram

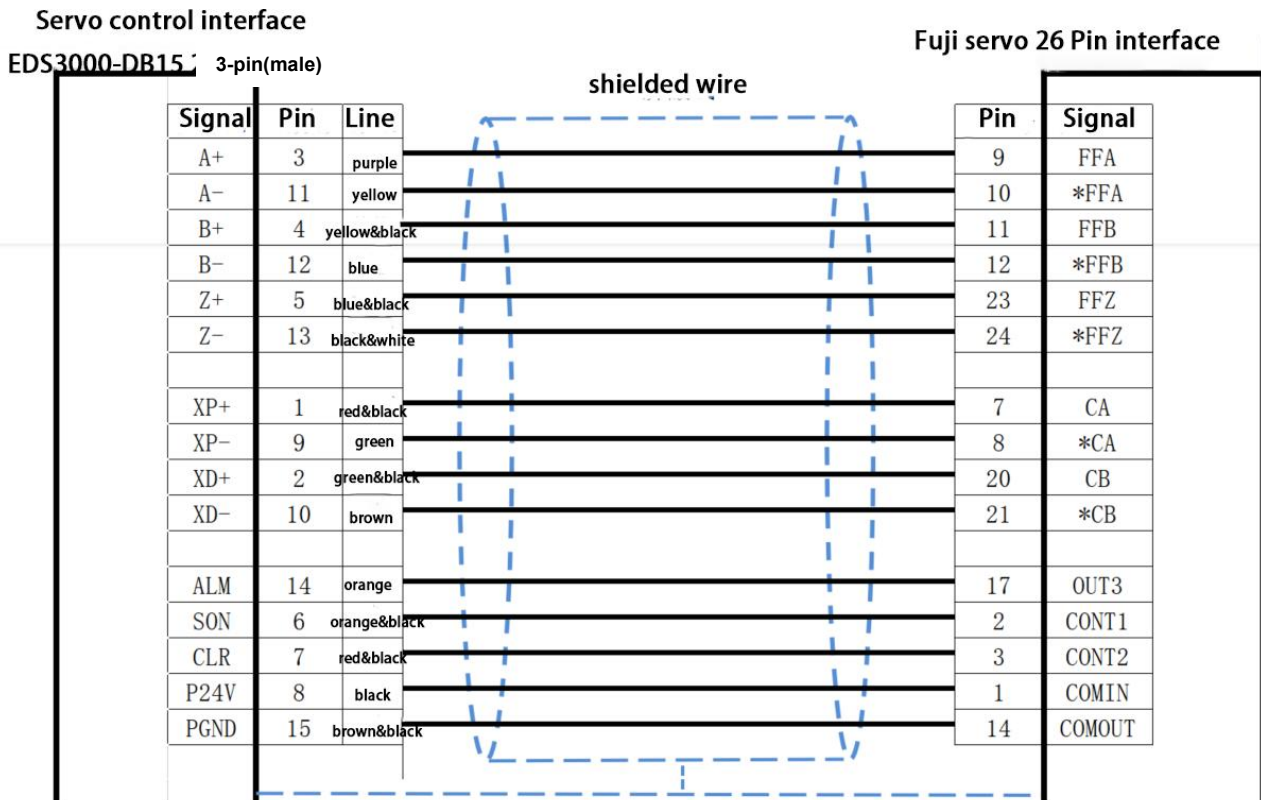

Fuji Servo Setting Parameters		
Parameter Type	Recommended Value	Setting range
PA-101	0	0...position 1...speed 2...torque 3...position <=> speed 4...position <=> Torque 5...Speed <=> Torque 6...Extended mode 7...Positioning operation
PA-103	1	0...Differential input: Command pulse/symbol 1...Differential input: Forward pulse/reverse Pulse 2...differential input :90° bit phase difference 2 signal 10...open collector input Command pulse/symbol 11... open collector input: forward pulse/reverse pulse 12...open collector input :90° bit phase difference 2 signal

F-axis Yaskawa servo drive wiring diagram

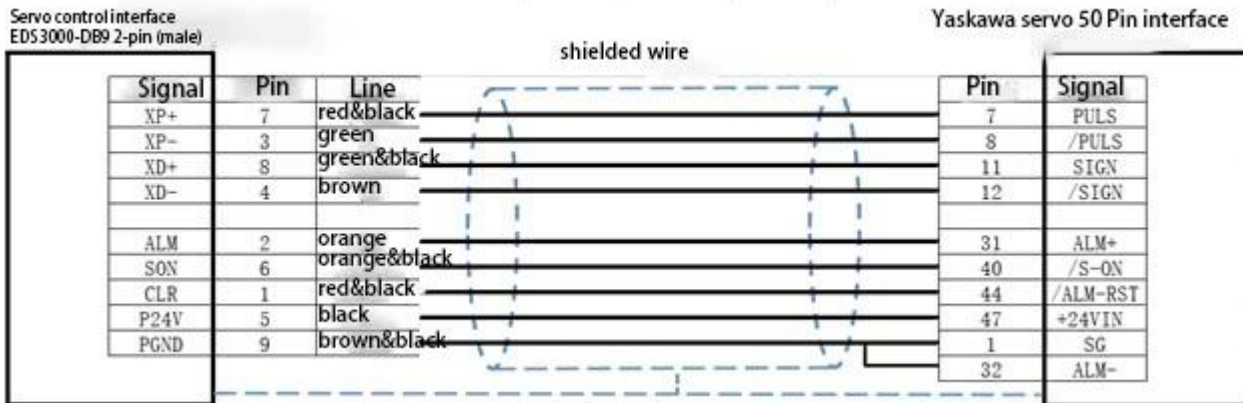

Leadshine Servo Drive Wiring Diagram

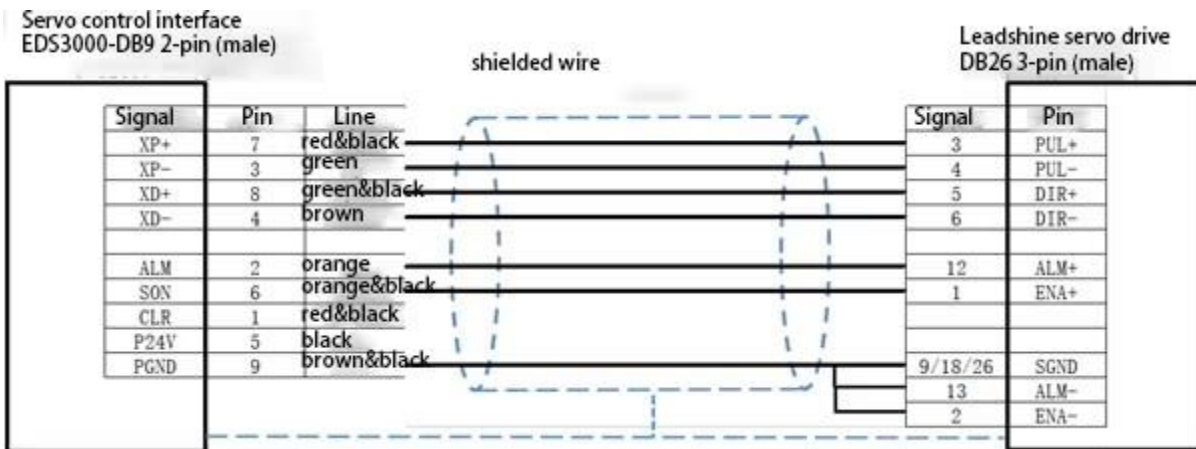

Leadshine Servo Series Basic Parameter

Parameter Type	Recommended Value	Setting range

System Commissioning Manual

P0-01	0	0...position 1...Speed 2...torque 3...position <=> speed 4...Position<=>Torque5...Speed<=> Torque
P0-07	3	3: Pulse + Direction
P0-12	1	Encoder feedback reversal

7.2 EDS3000 Wiring Diagram

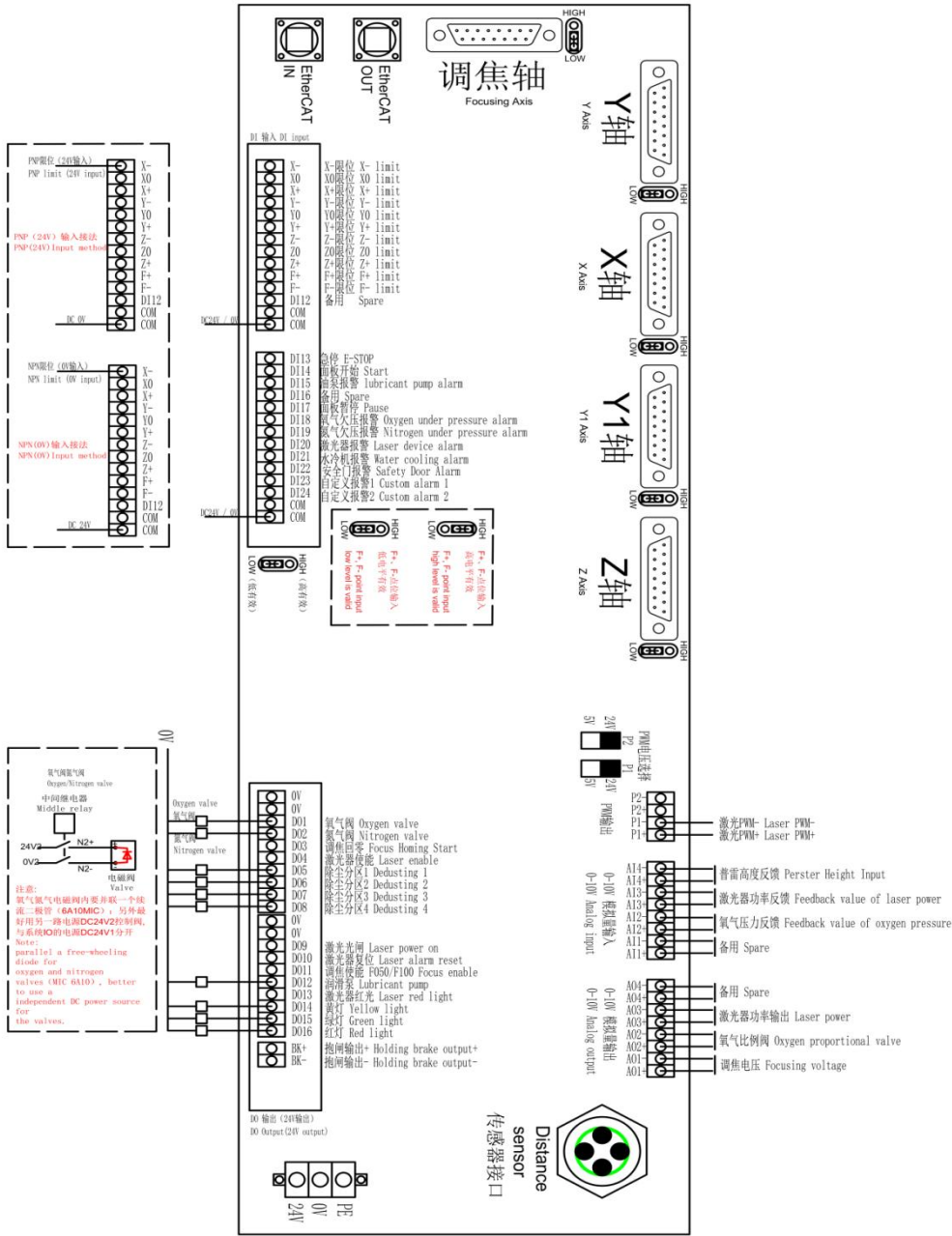

7.3 EDS2010 Wiring Diagram

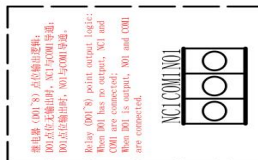
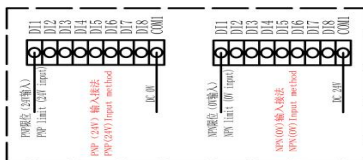
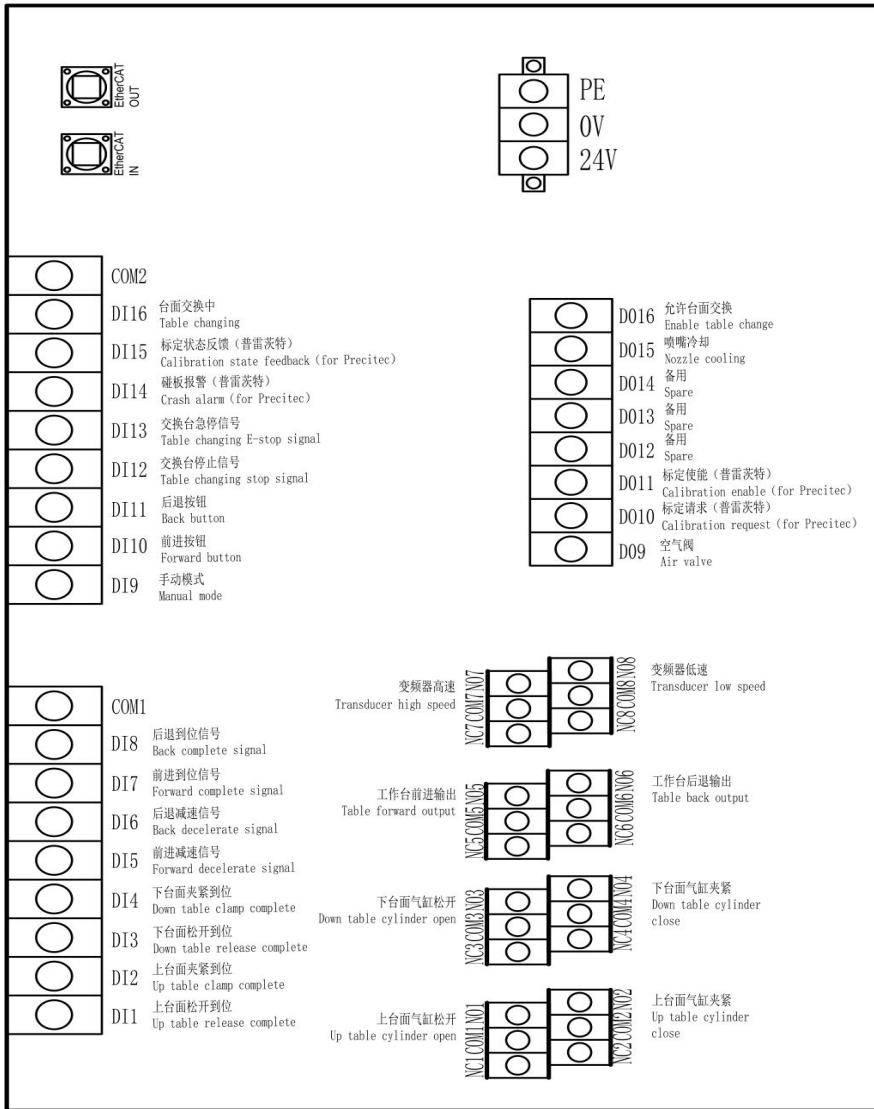

7.4 EPC-2000 Size Diagram

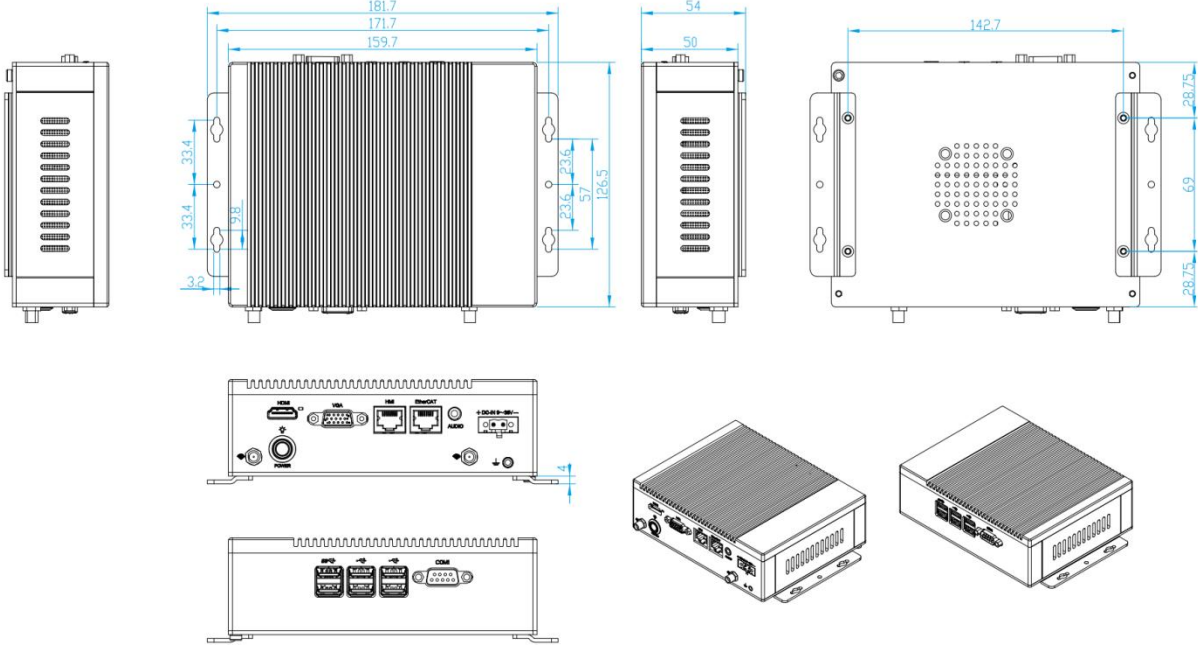

7.5 EPC-1020 Size Diagram

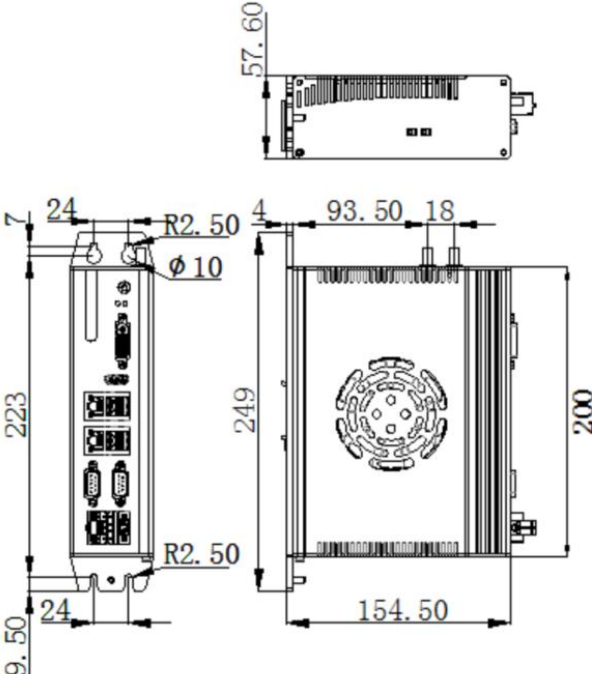

7.6 Parameter Definition

7.6.1 XY mechanical parameter and hardware config

X, Y-axis mechanical parameters		
Parameter Name	Default Value	Remarks
Encoder pulse number	10000	How many pulses are sent to the servo and the motor turns one revolution
Motor direction	Positive	Motor rotation direction is CW or CCW; when the shaft moves in the wrong direction, you can change this option
Pitch	36	The actual distance the shaft moves when the motor turns one revolution
Backlash compensation	0	For compensating the backlash of the gearbox
Max speed	60	Limit the maximum speed of the machine. When the command speed is greater than this speed, this speed is more accurate. The maximum speed and pitch of the motor are generally used to calculate the maximum speed
Max following offset	60	When the absolute value of the difference between the commanded position and the actual position is greater than this value, the software will alarm for stopping operating
Max acceleration	6000	The maximum value of acceleration, if any acceleration value is greater than this value, then this value shall prevail
Sync X parameters to Y	Unchecked	Synchronize X-axis mechanical parameters to Y-axis mechanical parameters
Sync Y parameters to X	Unchecked	Synchronize Y-axis mechanical parameters to X-axis mechanical parameters

System Commissioning Manual

Separate set	Selected	X-axis mechanical parameters and Y-axis mechanical parameters are not synchronized, set separately
Positive hard limit signal	DI3/D16 NO	Positive and hard limit pins can be set NO: no output for limit in untriggered state, select this item NC: output NC: output for limit in untriggered state, select this item
Zero signal	DI2/D15 NO	Settable zero pins NO: no output for limit in untriggered state, select this item NC: output for limit in untriggered state, select this item
Negative hard limit signal	DI2/D14 NO	Negative hard limit pins can be set NO: no output for limit in untriggered state, select this item NC: output for limit in untriggered state, select this item
Servo axis		Fill in according to the actual configuration
Soft limit range	0~ 1500	Range of X-axis movement of the cutting head after the software returns to zero
All limits NO	Unchecked	X-axis and Y-axis limit signals are all NO
All limits NC	Unchecked	All X-axis and Y-axis limit signals are NC
Separate set	Selected	X-axis and Y-axis limit signals are set separately

Dual-drive parameters		
Parameter Name	Default Value	Remarks
Slave axis Y1 port	axis	Select axis and fill in according to the actual configuration
Master-Slave Axes SYNC Dir	Reverse	Y1 axis motor rotation direction
Max offset in Master-slave SYNC	10mm	When the absolute value of the difference between the commanded position and the actual position is greater than this value, the software will alarm and shut down.
Duration	0 ms	Alarm for continuously reaching the set time exists exceeds the maximum tolerance error
Master slave stop state error	1mm	In static conditions, if the absolute value of the difference between the commanded position and the actual position is greater than this value, the software will alarm and shut down.

7.6.2 Pitch

Pitch parameters		
Parameter Name	Default Value	Remarks
Open Pitch Compensation	Unchecked	Enable and disable the pitch compensation function for the corresponding axis
Reverse Offset	None	Interferometer parameters are inverted, and the error is inverted for actual conditions

7.6.3 X/Y Back origin parameter

X/Y-axis Back origin parameters		
Parameter Name	Default Value	Remarks
Return origin mode	Absolute	Incremental: find the zero signal back to zero and use the zero signal as a reference point Absolute: move to the zero position of the driver feedback, the Position 0 of the drive feedback is the reference point
Return origin direction and type	Negative direction, zero position	Positive: When returning to zero, move in the positive direction Negative: When returning to zero, move zero in the negative direction: Zero position: Use zero as the reference point to return to zero Limit: determined according to the return to zero direction, if the positive direction is selected, the positive limit is reference point back to zero; if negative direction is selected, the negative limit will be used as the reference point

System Commissioning Manual

		to return to zero
Return origin speed	1.8	Speed of finding the reference signal when returning to zero
Back distance	0	Distance from zero return to limit signal setback
Aft back set coordinate	0	Coordinate value of the reference switch in the coordinate system
Absolute zero offset	0	Use the current point as the zero point; commissioning without limit switches You can use it for temporary debugging when

7.6.4 Z-Axis follow parameter

Z-axis follow parameters		
Parameter Name	Default Value	Remarks
Pulse number	10000	How many pulses to send to the servo, the motor turns one revolution
Motor direction	Positive	The motor rotation direction is CW or CCW; when the shaft moves in the wrong direction, it can change this option
Pitch	10	The actual distance the shaft moves when the motor turns one revolution
Speed unit of drive	pulse/s	Selectable pulse/s, 0.1RPM, RPM
Speed loop feedforward coefficient	0.01	Default is fine
Max follow-up offset	30	When the absolute value of the difference between the commanded position and the actual position is greater than this value, the software will alarm and shut down.
Homing mode	Incremental	Incremental: Find the zero signal back to zero and use the zero signal as a reference point

System Commissioning Manual

		Absolute: Move to the zero position of the drive feedback, with the position 0 of the drive feedback as the reference point
Return origin direction and type	Positive	Positive: When returning to zero, move in the positive direction to find the return to zero, refer to the switch Reverse: When returning to zero, move in the negative direction to find the return to zero, refer to the switch
Return to home signal	Limit	Limit: Use the limit as a return to zero reference switch Zero position: use zero position as a return to zero reference switch
Return origin speed	0.9	Speed of finding the reference signal when returning to zero
Back distance	5	Distance from zero return to limit signal setback
Coordinate aft backward set as	0	Coordinate value of the reference switch in the coordinate system
Origin point offset compensation	0	Use the current point as the zero point; for temporary debugging when commissioning without limit switches
Servo axis	axis	Fill in according to the actual configuration
Positive hard limit signal	DI9 NO	Positive and hard limit pins can be set NO: no output for limit in untriggered state, select this item NC: output for limit in untriggered state, select this item
Negative hard limit signal	DI7 NO	Negative hard limit pins can be set NO: no output for limit in untriggered state, select this item NC: output for limit in untriggered state, select this item
Soft limit range	- 100~2	Range of Z-axis movement of the cutting head after the software returns to zero
Back output	DI6	Settable holding brake output pins

7.6.5 Verticality correction

Verticality correction parameters		
Parameter Name	Default Value	Remarks
Start verticality correcting	Unchecked	Turn on and off the verticality correction function
Length AB	100mm	Verticality correction function tests the length of one side of a cut rectangle
Length AC	100mm	Perpendicularity correction function tests the length of the other side of the cut rectangle
Length L1	141.4mm	The length of one diagonal of the actual cut rectangle, which needs to be measured. After that, fill in that length here
Length L2	141.4mm	The length of the other diagonal of the rectangle after the actual cutting, which needs to be measured. After measuring, fill in that length here

7.6.6 Laser head

Laser head		
Parameter Name	Default Value	Remarks
Brand	RAYTOOLS	Select the cutting head brand
Model	BT210/240	Select the cutting head model
Focus control mode	Manual Focusing	Choose according to the type of focus supported by the cutting

System Commissioning Manual

		head
Height sensor type	EDS On-Board Capacitive Sensors	Select by actual heightening equipment
Height sensor signal port	Not used	Choose by actual configuration

7.6.7 Laser Device

Laser Device parameters		
Parameter Name	Default Value	Remarks
Laser Shutter	DO9	Pin selection according to actual wiring
Laser Red Light	DO13	Pin selection according to actual wiring
Laser Enable	DO4	Pin selection according to actual wiring
Laser Reset	DO10	Pin selection according to actual wiring
Shutter and Red light are mutually exclusive.	unchecked	When checked, the red light button and the light gate button are mutually exclusive and cannot be turned on at the same time
Laser power	A03	Pin selection according to actual wiring
All outputs of PWM	Check	Just check the default box
Laser Alarm	Not in use, NO	Settable laser alarm pins Alarm signal can be selected as NO or NC
Chiller Alarm	Not in use, NO	Chiller alarm pins can be set Alarm signal can be selected as NO or NC
Safety door alarm	Not in use, NO	Settable safety door alarm pins Alarm signal can be selected as NO or NC

System Commissioning Manual

Safety door alarm stop processing	Unchecked	When checked, processing will be stopped when the safety gate alarm is activated during processing
Laser brand	IPG	Just choose by the actual laser brand
Laser power	1000	Average power of the filled laser
Frequency	5000	Fill in the laser frequency, commonly 5000Hz
Voltage of max power	10	Fill in the maximum value of the laser feedback power analog, commonly 5V and 10V
Feedback voltage of max power	10	Fill in the maximum value of the laser feedback power analog, common 5V and 10V Output delay 0 are filled in advance.
Analog output delay	0	The analog output is filled in advance and then output enable signal and PWM signal, generally for 50ms
FlyCut laser on delay	0	How many ms in advance of the flying cut? This parameter is usually filled in 0, and it is recommended to use the advance distance in the nesting to adjust whether the flying cut contour is closed or not.
FlyCut laser off delay	0	How many ms of flying cut lag to turn off the light? This parameter is usually filled in 0, and it is recommended to use the advance distance in the nesting to adjust whether the flying cutting contour is closed or not.

7.6.8 Assist gas cell valve and analog output settings

Assist gas setting parameters		
Parameter Name	Default Value	Remarks
Air Magnetic Valve	DO9	Settable air magnetic pin
Air Proportional Valve Power	Not used	Settable air proportional valve power pin
Air Max Pressure	10	Max pressure supported by the air proportional valve, e.g., if using 0-10BAR proportional valve, this value could be 10.
Air Proportional Valve Analog	Not used	Settable proportional analog pins
Oxygen Magnetic Valve	DO1	Settable oxygen solenoid pin
Oxygen Proportional Valve Power	Not used	Settable oxygen proportional valve power pin
Oxygen Max Pressure	10	Max pressure supported by the air proportional valve, e.g., if using 0-10BAR proportional valve, this value could be 10.
Oxygen Proportional Valve Analog	AO2	Settable proportional valve analog pin
Nitrogen Magnetic Valve	DO2	Settable nitrogen magnetic Valve pin
Nitrogen proportional cell valve	Not used	Settable nitrogen proportional cell valve pin
Nitrogen Max Pressure	30	Max pressure supported by the nitrogen proportional valve, e.g., if using 0-30BAR proportional valve, the value can be 30.
Nitrogen Proportional Valve Analog	Not used	Settable nitrogen proportional valve analog pin
Main Magnetic Valve	Not used	Settable main magnetic valve

System Commissioning Manual

Close the power supply of all proportion valves after the procedure.	Unchecked	When checked, all proportional valve power is turned off after the processing program is rushed.
Enable cutting head air cooling	Unchecked	When checked, blowing is turned on when the light comes out and off when the light stops.
	Not used	Cutting head air cooling solenoid valve port setting
Air digital gas pressure alarm	Not used	Settable air digital gas pressure alarm input pin
Oxygen digital gas pressure alarm	DI18	Settable oxygen digital gas pressure alarm input pin
Nitrogen digital gas pressure alarm	DI19	Settable nitrogen digital gas pressure alarm input pin
Air digital gas pressure alarm logic	NO	NO: No signal output in untriggered, select this item NC: signal output in untriggered, select this item
Oxygen digital gas pressure alarm logic	NO	NO: No signal output in untriggered, select this item NC: signal output in untriggered, select this item
Nitrogen digital gas pressure alarm logic	NO	NO: No signal output in untriggered, select this item NC: signal output in untriggered, select this item
Air analog gas pressure feedback	Not used	Settable air analog gas pressure feedback pin
Oxygen analog gas pressure feedback	Not used	Settable oxygen analog gas pressure feedback pin
Nitrogen analog gas pressure feedback	Not used	Settable nitrogen analog gas pressure feedback pin
Suspend processing when gas pressure alarm on	Opening	Stopping processing for gas pressure alarm

7.6.9 Dust removal valve

Dust removal valve parameters		
Parameter Name	Default Value	Remarks
Enable partition output	checked	Whether to open the dust removal function
Row & Col	4/1	Number of rows and columns of partitioned dusting arrays
Dust removal axis	DO5-DO8	Which axis coordinate is used to open the dust cylinder?
Overlaid area length (XY)	20/20	Common zone with the next dusting area, in which this dusting and the next dusting point will be turned on at the same time to ensure the dusting effect
Close output port delay	checked	After leaving the dusting area, the dusting output is closed with a delay to avoid frequent opening and closing of the dusting solenoid valve when the shaft is moving at the boundary of the area.
Only open output in cutting	checked	When checked, the dust removal points are only output when the light is out
Custom removal length	1500*3000	Distance to set up dust removal length

7.6.10 Alarms

System Commissioning Manual

Alarms parameters	
Parameter Name	Remarks
ID	Corresponds to custom alarms number 1, 2, 3
Alarm info (CNS)	In Chinese language, this message will be printed after the alarm
Alarm info (EN)	In English language, this message will be printed after the alarm
Logic	Select whether the alarm signal is NO or NC, according to the actual choice
Process allow	When checked, allow processing when an alarm occurs When unchecked, not allow processing when an alarm occurs
Node Configuration	Settable custom alarm input pin
All NO	After clicking, all custom alarms have become NO
All NC	After clicking, all custom alarms have become NC
All allow	After clicking, allow processing when custom alarm occurs
All deny	After clicking, not allow processing when custom alarm occurs

7.6.11 Button

Button	
Parameter Name	Remarks
Number index	Corresponds to custom buttons number 1, 2, 3
Used	When checked, the HMI interface will display this button
Cmd ID	Default
Name (CNS)	Button (Chinese)
Name (EN)	Button (English)
Signal type	Set the alarm signal as hold or trigger type
Node configuration	Settable custom button output pin
Enable all	After clicking, all custom buttons are enabled
Disable all	After clicking, all custom buttons are disabled
All Hold-type	After clicking, all custom buttons are now in the holding-type
All Triggered-type	After clicking, all custom buttons are in triggered-type

7.6.12 Physical button

Physical button		
Parameter Name	Default Value	Remarks
Start signal logic	DI14 NO	Settable start signal input pins NO: No signal output in untriggered, select this item. NC: signal output in untriggered, select this item.
Pause signal logic	DI17 NO	Settable pause signal input pins NO: No signal output in untriggered, select this item. NC: signal output in untriggered, select this item.
Reset signal logic	Not use NO	Settable reset signal input pins NO: No signal output in untriggered, select this item. NC: signal output in untriggered, select this item.
Emergency stop alarm logic	DI13 NO	Settable emergency stopping alarm signal input pins NO: No signal output in untriggered, select this item. NC: signal output in untriggered, select this item.
Red light	DO13	Red light of tricolor lamp
Yellow light	DO14	Yellow light of tricolor lamp
Green light	DO15	Green light of tricolor lamp

7.6.13 Pallet changer

Input Signal parameters		
Parameter Name	Default Value	Remarks
Start pallet changer	Unchecked	When checked, the pallet changer is started.
Type	Horizontal panning	Optional horizontal translation, hydraulic lift, motor lift, servo axis exchange, Y-axis pulling, external exchange table Selection based on actual pallet changer.
Emergency stop	Not used NC	Settable emergency stopping alarm signal input pin pallet changer emergency stop signal
Stop	Not used NC	Settable stopping alarm signal input pins pallet changer stop signal
Forward in-p o s	Not used NC	Settable input pins for sense signals. Select sense signal of the pallet changer according to the actual configuration
Backward in-p o s	Not used NC	
Forward deceleration	Not used NC	
Backward deceleration	Not used NC	

System Commissioning Manual

Up-row unclamped in-pos login	Not used NC	Settable top-row loose-in-place input pin The output logic of the upper table fixed cylinder opening in place sensor
Up-row clamped in-pos login	Not used NC	Settable top row clamping in place input pins The output logic of the upper table fixed cylinder clamping in place sensor
Lower-row unclamped in-pos login	Not used NC	Settable lower row release in place input pins output logic of the lower table fixed cylinder opening in place sensor
Lower row clamped in-pos login	Not used NC	Settable lower row clamping in place input pins The output logic of the lower table fixed cylinder clamping in place sensor
Cylinder unclamped in-pos signal	Not used None	Settable cylinder release in place pin Fill in the actual configuration; if you choose none, after the signal output, it will wait for the time to fill in (wait for the cylinder to open completely), and then move the pallet changer.
Cylinder clamped in-pos signal	Not used None	Fill in according to the actual configuration
Dual pallet use one cylinder	Close	Settable ON or OFF
Jog/Auto mode switch	Use IO	Use IO: use external signal to switch between manual and automatic modes Use HMI: use the software interface to switch between manual and automatic modes
Paller changer with bolt	No	Fill in according to the actual configuration

Output Signal parameters		
Parameter Name	Default Value	Remarks
Forward	Not used	Settable forward signal output pin
Backward	Not used	Settable backward signal output pin
High speed	Not used	Settable High speed signal output pin
Low speed	Not used	Settable low speed signal output pin
Up-pallet cylinder unclamped	Not used	Settable up-pallet cylinder unclamped output pin
Up-pallet cylinder clamped	Not used	Settable up-pallet cylinder clamped output pin
Low-pallet cylinder unclamped	Not used	Settable low-pallet cylinder unclamped output pin
Low-pallet cylinder clamped	Not used	Settable low-pallet cylinder clamped output pin

Hardware Button

System Commissioning Manual

Parameter Name	Default Value	Remarks
Forward	Not used, NC	Settable forward button input pin Fill in the actual configuration, if there is no this button, please select NO
Backward	Not used, NC	Settable backward button input pins Fill in the actual configuration, if there is no this button, please select NO
OneKey exchange	Not used, NC	Settable oneKey exchange input pin Fill in the actual configuration, if there is no this button, please select NO
Ascent	Not used, NC	Settable ascent button input pin Fill in the actual configuration, if there is no this button, please select NO
Descent	Not used, NC	Settable descent input pin Fill in the actual configuration, if there is no this button, please select NO
Jog/Auto mode switch	Enable hardware signals	Optional IO or HMI

System Commissioning Manual

Parallel exchange		
Parameter Name	Default Value	Remarks
Pallet changer with bolt	No	Fill in according to the actual configuration
Bolt unclamped in-pos	No	Fill in according to the actual configuration, Settable delay time
Bolt clamped in-pos	None	Fill in according to the actual configuration
Up-bolt unclamped in-pos logic	Not used, NC	Settable up-bolt unclamped in-pos input pin Up-bolt unclamped in-pos sensor logic. If this signal is available, just select it according to the actual configuration; If this signal is not available, select NO.
Up-bolt clamped in-pos logic	Not used, NC	Settable up-bolt clamped in-pos input pin Up-bolt clamped in-pos sensor logic.
Low-bolt unclamped in-pos logic	Not used, NC	Settable low-bolt unclamped in-pos input pin Low-bolt unclamped in-pos sensor logic.
Low-bolt clamped in-pos logic	Not used, NC	Settable low -bolt clamped in-pos input pin Low-bolt clamped in-pos sensor logic.
Up-pallet bolt unclamped	Not used	Settable up-pallet bolt unclamped output pin
Up-pallet bolt clamped	Not used	Settable up-pallet bolt clamped output pin
Low--pallet bolt unclamped	Not used	Settable low-pallet bolt unclamped output pin
Low--pallet bolt clamped	Not used	Settable low-pallet bolt clamped output pin
Z-axis up-pallet negative soft limit	0	When the up-pallet is in the cutting area, the Z-axis moves to this coordinate at the lowest

System Commissioning Manual

Z-axis middle limit logic	Not used, NC	When the upper table is in the cutting area, Z-axis hardware limit logic (different from Z- limit; it can be considered that Z-limit is the negative limit of the lower table and this limit is the negative limit of the upper table) can be set in hard limit input pins
Forward in-pos signal reached pallet	Up-pallet	Fill in the actual configuration, it will determine which table is currently in the cutting area, based on this parameter.
Cylinder only output after the pallet is in place.	Unchecked	Check the box according to the actual situation

7.6.14 Lubrication

Parameter Name	Remarks
Interval	Output interval of lubrication pump
Duration	Duration of each output of the lubrication pump
Pump overpressure alarm	Settable alarm input pin and logic for oil pump alarm points
Low oil alarm	
Oil pump output	Settable oil pump output pin

7.6.15 Segmented axis parameters

Servo parameters		
Parameter Name	Default Value	Remarks
Motor direction	Negative	The motor rotation direction is CW or CCW; when the shaft moves in the wrong direction, this option can be changed.
Speed unit of drive	pulse/s	Selectable pulse/s, 0.1RPM, RPM
Speed loop feedforward coefficient	0.01	Default

System Commissioning Manual

Max follow-up offset	5mm	When the absolute value of the difference between the commanded position and the actual position is greater than this value, the software will alarm and shut down.
System Latency	5	Axis motion delay time
Manual slow	0.12m/min	Running slowly in manual mode
Manual fast	0.24m/min	Run fast in manual mode
Speed	1.8m/min	Running speed in automatic mode
Acceleration	2000mm/s	Running acceleration in automatic mode
Acc time	500	Time to run acceleration completion in automatic mode
Motor polarity	1	Under torque control, changing the motor polarity can change the direction of motion
Max torque	200	Max torque value
Torque feedforward	0	Default
Adjmt. coefficient		
Homing mode	Absolute	Incremental: Find the zero signal back to zero and use the zero signal as the reference point Absolute: Move to the zero position of the driver feedback with the position 0 of the driver feedback as the reference point

System Commissioning Manual

Return origin direction and type	Positive, Limit	<p>Positive: When returning origin, move in the positive direction to find the return to zero reference switch.</p> <p>Reverse: When returning origin, move in the negative direction to find the return to zero reference switch</p> <p>Limit: Use the limit as the return origin reference switch</p> <p>Zero position: Use zero position as the return origin reference switch</p>
Return origin speed	0.12m/min	Speed of finding the reference signal when returning origin
Back distance	5 mm	Distance from zero return to limit signal setback
Coordinates aft backward set as	0	Coordinate value of the reference switch in the coordinate system
Origin point offset compensation	0 mm	The current point as the zero point; commissioning without limit switches for temporary commissioning
Servo axis	Not used	Fill in according to the actual configuration
Positive limit signal		<p>Settable positive hard limit pin</p> <p>NO: no output in the untriggered state, select this item</p> <p>NC: output in untriggered state, select this item</p>
Soft limit	Open	<p>Settable negative hard limit pin</p> <p>NO: no output in the untriggered state, select this item</p> <p>NC: output in untriggered state, select this item</p>
Soft limit range	-10~10mm	The range of axis movement after the software returns origin
Axis taq		Current axis for labeling, detailed information notes

7.6.16 Advanced option

Advanced option parameters		
Parameter Name	Default Value	Remarks
DX150P position loop mode (HMI version greater than 5609)	Unchecked	You can choose whether or not to search for edges before processing in the software interface after checking the box.
Enable NozzleClean	Unchecked	The software supports nozzle cleaning after checking the box.
Enable Nest	Checked	Supporting nesting function after checking the box.
Docking points follows selected shape	Unchecked	The docking point changes with the selected drawing; unchecked, the docking point is planned according to the entire drawing, after checking the box.
Fix point motion speed is manual fast (default speed: G00)	Unchecked	The interface uses manual speed for all fast-positioning movements after checking the box; unchecked for duty speed.
Enable servo gantry axis control	Unchecked	Checking special parts supports part of the support gantry drive available; not recommended to arbitrarily check the box, and if you have such requirements, please contact our after-sales professionals.
Display maintenance module	Unchecked	Support the maintenance function after checking the box.



Shanghai Jiaqiang Automation Technology Co.

Address: 8 Dongbao Road, Songjiang District, Shanghai,

Hotline: 400-670-1510

Email: sales@empower.cn

Website: www.empower.cn